

SALT- & FRESHWATER

CATALOGUE

2023/2024



AQUA/MEDIC

Valid from: 01/06/2023



	page
Aquaria	5 – 12
Seasalt	13
Hydrometer	14 – 15
Saltwater supplements	16 – 20
Special nutrition	21 – 22
Algal resources	22
Freshwater supplements	23 – 24
Plankton	25
Heating / cooling	26 – 29
Pumps	30 – 41
Protein skimmer	42 – 48
Filter systems	49 – 54
Filter components	55
Filter material	56 – 59
UV-C sterilizer	60 – 61
Light	62 – 72
Measurement and control technology	73 – 82
Reverse osmosis	83 – 90
CO ₂	91 – 92
aqua tools	93 – 108

AQUA MEDIC recommends:

-  suitable for saltwater
-  suitable for freshwater
-  suitable for salt- and freshwater

Subject to technical changes and errors.

	page		page		page
6-tubes	41	extension cord DC Runner / EcoDrift	32, 35	Qube 40	66
AC Runner series x.2	36	ferreal + spureal	23	Qube 50 plant	69
Adapter union AM	106	Filter accessories 15 x 15	104	Qube 60	67
AM PRO	37	filter bag	56, 97	Qube control	70
aminovit	21	filter bag multi	56, 97	reactor 100	92
antibac filter	88	Filter Box A/B	49	reactor 1000	92
antiphos Fe	57	Fish trap	96	reactor compact	91
aqua +GH	23	fishknob	12	Reducing T-piece	107
aqua +KH	23	floreal + iod	24	Reef Construct	101
aqua divider	107	Fluidized bed filter FB 5000	55	REEF LIFE series	16 – 19
aqua gloves	94	food pipe	11, 95	Reef Salt / Reef Salt coral	13
aqua grid	104	frag board	102	reefdoser EVO 1/3/5	40
Aqua Medic seasalt	13	heat controller duo II	29, 74	reefdoser EVO 4	40
aqua smoothy	101	Helix Max 2.0	60	refill depot	54
aquabiovit	21	hopstop	11, 103	Refill System 2.0 + Refill System easy	53
aquabreed complete	24	hose clip	41, 103	refractometer LED	15
aquafit series	72	hot construct	101	regular	92
aqualife + Vitamine	23	Hydrocarbonat	19	Regulation valve	108
aquarius plant plus	64	indicator-resin	84	Reverse osmosis accessories	89 – 90
aquarius plus	63	injection set	95	RO-resin	89
aquarius plus holder BW	10, 65	K1	44	RO-resin cartridge	84
arctic breeze	26	Kalkwasserpowder	17	Round grate	106
Armatus	5	LED FA	71	rubber sucker twin	96
Armatus Lagoon 400	7	LF controller	77	Rust Protect	12, 108
Armatus XD	6	magnetscraper blades	100	salimeter	14
Armatus XS	8	Mega Mag	99	scissors 60	93
BactoBalls	57	Mega Mag magnetscraper	100	scissors 60 curved	93
Bali Sand	20	Merlin plus (PRF-RO)	88	scraper	100
Blenny Qube	10	micro heater	28	Silencer	48
bubble counter plus	91	midifloter	47	Silicagel	80
Cabinet Protect	49	Mini-Deniballs	59	silicone hose 4/6	91, 95
carbolit	57	minifloter	47	SmartDrift series x.1	31
catch bowl	95	Mistral	38	SP 3000 Niveumat	41
CO2	91 – 92	Mistral II	39	spectrus / spectrus twin	62
combfix	106	multi reactor-Gen II series	55	spectrus holder BW	11, 65
connection cord DC 0 – 10 V	32, 35	mV computer-Set	76	spot control	71
cool control	29, 73	mV controller	76	sulfur pearls	58
Coral Construct	101	mV monitor	76	Systemfilter series	50 – 52
coral cutter	94	M-ventil Eco	81	T controller	73
coral fit	22	NO3 reduct	22	T controller twin	28, 73
Coral Glasses	98	Non-return valve	108	Tank union	106
Coral holder	103	Ocean Queen	43	tap connector	90
coral pins	102	Outlet strainer	107	Test fluids	82
Coral strap	103	Overflow comb / comb series	105	Titan Professional series	27
counter	92	ozone	79	Titan series	26
Cubicus CF Qube	9	Ozone Booster	80	Titanium Heater	27, 74
DC Runner 400 – 1000	33	Ozoniser	80	T-meter	77
DC Runner series x.3	34	pH computer-Set	75	T-meter II	77
defroster	102	pH controller	74	T-meter twin	78
Demineralisation filter	89	pH monitor	75	Tonga Pearls	20
Deniballs	58	pH-control-Set	75	Top End Filter	87
Denigran	58	pipette 35 + pipette 60	22	TopView 200	98
denimar	59	plancto	21	t-rail 60	93
DensiMeter	14	plankton light reactor II	25	Trap-pest	96
DensiTower	14	plankton reactor	24	Tri Complex compact	16
easy line	86	platinum line plus	83	Turbofloter 10000	46
easy line Filter Sets	85, 86	plexipad Mega Mag	100	Turbofloter 20000	47
easy line professional	85	power floter series x.3	42	Turbofloter 5000 / 5000 shorty II	46
EcoDrift series x.3	30	prefilter bag	56, 97	tweezers 60	93
Electrode holder	82	premium line	87	UV-C Professional	61
Electrodes	81	pump brush	102	valve	107
EVO series	45	Qube 30 plant	68	Wooden airstones	48

Armatus 250/300/400/450

Rimless saltwater aquarium incl. cabinet filter system

- aquarium without brace bars made from ultra clear (low iron) glass with polished edges
- silent operation due to the "easy drain system"
- filter tank with adjustable water level and automatic refill
- fine filter area with replaceable filter bags
- transportable refill tank
- glass cabinet filter with prefilter chamber, two clear water chambers for use with additional biological and mechanical filters (e. g. skimmer, multi reactor, etc.) and filter media
- integrated emergency overflow
- elegant glass duct cover
- high-quality cabinet with softclose, white high gloss
- large base cabinet with aeration and ventilation
- incl. drip pan
- the cabinet is supplied flat packed for easy transportation and home assembly with few parts

Armatus	Armatus 250	Armatus 300	Armatus 400	Armatus 450
Dimensions aquarium (l x w x h) app.	75 x 50 x 55 cm	100 x 50 x 55 cm	125 x 50 x 55 cm	150 x 50 x 55 cm
Glass thickness front pane	10 mm	12 mm	15 mm	15 mm
Glass thickness side pane	8 mm	10 mm	10 mm	12 mm
Glass thickness back wall	8 mm	10 mm	10 mm	12 mm
Glass thickness bottom pane	10 mm	10 mm	12 mm	12 mm
Volume aquarium app.	190 l	250 l	315 l	375 l
Water level app.	50 cm	50 cm	50 cm	50 cm
Dimensions filter cabinet (l x w x h) app.	60 x 42 x 34 cm	60 x 42 x 34 cm	90 x 42 x 34 cm	90 x 42 x 34 cm
Water level filter cabinet max.	16 – 23 cm	16 – 23 cm	16 – 23 cm	16 – 23 cm
Dimensions skimmer compartment	43 x 27 cm	43 x 27 cm	51 x 40 cm	51 x 40 cm
Dimensions pump compartment	43 x 11 cm	43 x 11 cm	40 x 20 cm	40 x 20 cm
Volume filter cabinet app.	55 l	55 l	85 l	85 l
Total volume	245 l	305 l	400 l	460 l
Volume refill l tank	10 l	10 l	16 l	16 l
Recommended circulation pump (not included)	DC Runner 2.3	DC Runner 3.3	DC Runner 3.3 / 5.3	DC Runner 5.3
Dimensions incl. cabinet (l x w x h) app.	75 x 50 x 145 cm	100 x 50 x 145 cm	125 x 50 x 145 cm	150 x 50 x 145 cm
Dead weight app.	99 kg	125 kg	159 kg	194 kg
Inlet to the filter Ø approx.	40 mm	40 mm	40 mm	40 mm
Return line to the aquarium (hose/inside) Ø approx.	25 mm	25 mm	25 mm	25 mm
Emergency overflow Ø approx.	25 mm	25 mm	25 mm	25 mm

For further technical details please refer to www.aqua-medice.de

Item code	Item
510.014	Armatus 250 white
510.114	Armatus 300 white
510.214	Armatus 400 white
510.314	Armatus 450 white



Armatus 250



Armatus 300



Armatus 400



Armatus 450



Armatus XD 300



Armatus XD 375



Armatus XD 500



Armatus XD 575

Armatus XD 300/375/500/575

Rimless saltwater aquarium incl. cabinet filter system

- aquarium without brace bars made from ultra clear (low iron) glass with polished edges
- 65 cm aquarium depth - more space for reef design
- integrated emergency overflow
- elegant easy-to-clean glass duct cover
- silent operation due to the "easy drain system"
- filter tank with adjustable water level and automatic refill
- fine filter area with replaceable filter bags
- transportable refill tank
- glass cabinet filter with pre-filter chamber, two clear water chambers for use with additional biological and mechanical filters (e. g. skimmer, multi reactor, etc.) and filter media
- high-quality cabinet with softclose, white high gloss
- extra stable cabinet walls of 28 mm (for the 500 and 575 version also the middle wall)
- large base cabinet with aeration and ventilation
- incl. drip pan
- the cabinet is supplied flat packed for easy transportation and home assembly with few parts

Armatus XD	Armatus XD 300	Armatus XD 375	Armatus XD 500	Armatus XD 575
Dimensions aquarium (l x w x h) app.	75 x 65 x 55 cm	100 x 65 x 55 cm	125 x 65 x 55 cm	150 x 65 x 55 cm
Glass thickness front pane	10 mm	12 mm	15 mm	15 mm
Glass thickness side pane	10 mm	10 mm	12 mm	12 mm
Glass thickness back wall	8 mm	10 mm	10 mm	12 mm
Glass thickness bottom pane	10 mm	10 mm	12 mm	12 mm
Volume aquarium app.	245 l	325 l	405 l	490 l
Water level app.	50 cm	50 cm	50 cm	50 cm
Dimensions filter cabinet (l x w x h) app.	60 x 42 x 34 cm	60 x 42 x 34 cm	90 x 42 x 34 cm	90 x 42 x 34 cm
Water level filter cabinet max.	16 – 23 cm	16 – 23 cm	16 – 23 cm	16 – 23 cm
Dimensions skimmer compartment	43 x 27 cm	43 x 27 cm	51 x 40 cm	51 x 40 cm
Dimensions pump compartment	43 x 11 cm	43 x 11 cm	40 x 20 cm	40 x 20 cm
Volume filter cabinet app.	55 l	55 l	85 l	85 l
Total volume	300 l	380 l	490 l	575 l
Volume refill l tank	10 l	10 l	16 l	16 l
Recommended circulation pump (not included)	DC Runner 3.3	DC Runner 3.3 / 5.3	DC Runner 5.3	DC Runner 5.3
Dimensions incl. cabinet (l x w x h) app.	75 x 65 x 145 cm	100 x 65 x 145 cm	125 x 65 x 145 cm	150 x 65 x 145 cm
Dead weight app.	138 kg	166 kg	225 kg	256 kg
Inlet to the filter Ø approx.	40 mm	40 mm	40 mm	40 mm
Return line to the aquarium (hose/inside) Ø approx.	25 mm	25 mm	25 mm	25 mm
Emergency overflow Ø approx.	25 mm	25 mm	25 mm	25 mm

For further technical details please refer to www.aqua-medic.de

Item code	Item
511.014	Armatus XD 300 white
511.114	Armatus XD 375 white
511.214	Armatus XD 500 white
511.314	Armatus XD 575 white

Armatus Lagoon 400

Rimless coral aquarium incl. cabinet filter system

- low height for creating lagoon landscapes
- lagoon optics enable a fantastic top view for viewing corals
- efficient light flooding thanks to the low height of 40 cm
- optimal conditions for creating laminar flow
- more energy-efficient than aquaria with standard height
- aquarium without brace bars made from ultra clear (low iron) glass with polished edges
- integrated emergency overflow
- elegant easy-to-clean glass duct cover
- silent operation due to the "easy drain system"
- filter tank with adjustable water level and automatic refill
- fine filter area with replaceable filter bags
- transportable refill tank
- glass cabinet filter with pre-filter chamber, two clear water chambers for use with additional biological and mechanical filters (e. g. skimmer, multi reactor, etc.) and filter media
- high-quality cabinet with softclose, white high gloss
- extra stable cabinet walls incl. middle wall of 28 mm
- large base cabinet with aeration and ventilation
- incl. drip pan
- the cabinet is supplied flat packed for easy transportation and home assembly with few parts
- foiling of the back wall possible for an additional charge



Armatus Lagoon 400

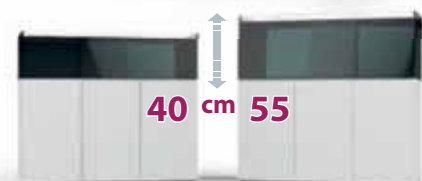

Armatus Lagoon / Armatus XD



Armatus Lagoon	400
Dimensions aquarium (l x w x h) app.	150 x 65 x 40 cm
Glass thickness front pane	12 mm
Glass thickness side pane	12 mm
Glass thickness back wall	12 mm
Glass thickness bottom pane	12 mm
Volume aquarium app.	355 l
Water level app.	35 cm
Dimensions filter cabinet (l x w x h) app.	90 x 42 x 34 cm
Water level filter cabinet max.	16 – 23 cm
Dimensions skimmer compartment	51 x 40 cm
Dimensions pump compartment	40 x 20 cm
Volume filter cabinet app.	85 l
Total volume	400 l
Volume refill l tank	16 l
Recommended circulation pump (not included)	DC Runner 5.3
Dimensions incl. cabinet (l x w x h) app.	150 x 65 x 130 cm
Dead weight app.	205 kg
Inlet to the filter Ø approx.	40 mm
Return line to the aquarium (hose/inside) Ø approx	25 mm
Emergency overflow Ø approx.	25 mm

Item code	Item
512.314	Armatus Lagoon 400



Armatus XS

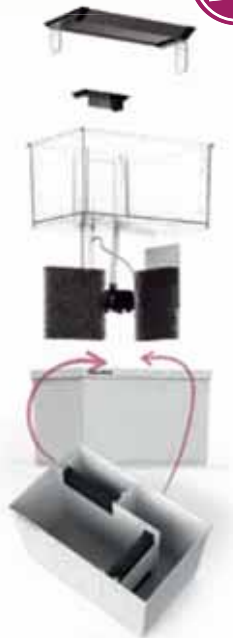

Armatus XS

All-in-One micro aquarium with cabinet filter

The Armatus XS comes equipped with LED lighting and a pump. The LED lighting can be individually adjusted with 2 light channels (white and blue) including dimming. The integrated feed pump also serves as a current pump and ensures sufficient water circulation. A built-in drain duct ensures reliable surface skimming. The sophisticated water flow ensures low-noise operation. Filter sponges, which can be placed in the base cabinet, ensure good water quality. The overall look is based on our successful concept of the Armatus series. The Armatus XS is suitable for salt and fresh water.

Included in delivery:

- Armatus XS with cabinet filter (plastic aquarium)
- aquarius XS - LED lighting (USB, 5 V) max. 10 watts (incl. USB connection cable)
- pump (USB connection, 5 V) 250 l/h
- filter sponge

Caution:

- a 5 V, min. 2.4 A, USB power pack is required for the lighting (not included in delivery)
- a 5 V, min. 1 A, USB power pack is required for the pump (not included in delivery)

Item code	Item
510.010	Armatus XS NEW

also available separately:

89001	aquarius XS NEW
-------	------------------------



according to EU regulation 2019/2015 and 2019/2020

Light source for germicidal applications with a peak radiation at 253.7 nm. For disinfecting water, not suitable for other applications.

Cubicus CF Qube

Saltwater aquarium incl. cabinet filter system

- aquarium made of 8 mm prime white glass front pane
- incl. glass cabinet filter, four-chamber system, prefilter chamber, two clear water chambers for putting up biological and mechanical filters (e. g. skimmer) and filter media, settling chamber
Dimensions (l x w x h): app. 40 x 47 x 45 cm, water level max. 32 cm, volume max. 54 l
- illumination: 2 x Qube 50 - High power LED spot. Five different light colours with high energy density specially designed for strong coral growth (24 V, max. 50 W). Colour and light intensity are adjustable manually via 2 channels. Integrated 0 – 10 V connection for using external controllers.
- circulation pump DC Runner 2.3 (24 V, max. 20 W)
- protein skimmer EVO 501 (24 V, max. 7 W)
- high-quality cabinet with softclose, completely mounted, white high gloss

Options:

- Aqua Medic Refill System 2.0 (see page 53)
- Helix Max 2.0 UV-C sterilizer 9 W (see page 60)

Dimensions (l x w x h): app. 50 x 60 x 150 cm

Water level: app. 45 cm, volume app. 135 l

Dead weight: app. 94 kg

Item code	Item
571.20	Cubicus CF Qube white

Water volume calculated before gravel or decoration.
Aquadria can be produced with alternative lighting, please inquire.



Cubicus CF Qube



Overflow Cubicus CF Qube



according to EU regulation 2019/2015 and 2019/2020

Light source for germicidal applications with a peak radiation at 253.7 nm. For disinfecting water, not suitable for other applications.



Blenny Qube



according to EU regulation 2019/2015 and 2019/2020

Light source for germicidal applications with a peak radiation at 253.7 nm.

For disinfecting water, not suitable for other applications.

Blenny Qube

Saltwater aquarium

Ready to go with proven technology and high quality components. Blenny combines the full functionality of a reef aquarium in a compact design. The integrated filter compartment guarantees easy maintenance. Made with 6 mm prime white glass.

Equipment:

- current: EcoDrift 4.3, located in the back wall, easily adjustable for desired water moment (800 – 4,000 l/hr, 24 V, 3 – 10 W).
- protein skimmer: EVO 501 (24 V, max. 7 W), efficient and near silent operation
- light: Qube 50-High power LED spot with balanced light spectrum. Five different light colours with high energy density specially designed for strong coral growth (24 V, max. 50 W). Colour and light intensity are adjustable manually via 2 channels. Integrated 0 – 10 V connection for using external controllers.

Dimensions: (l x w x h): app. 40 x 50 x 40 cm

Water level: app. 38 cm, volume: app. 76 l

Dead weight: app. 22 kg

Item code	Item
565.20	Blenny Qube

ACCESSORIES AQUARIA



aquarius plus holder BW

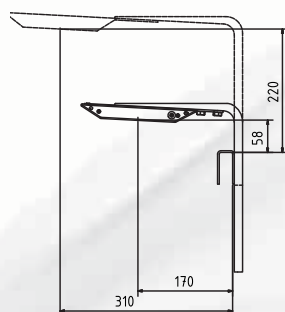

aquarius plus holder BW

Rear wall bracket, only for aquarius plus LED lights

aquarius plus	30	60	90	120
Recommended number of holders	1	2	2	2

Item code	Item
89706	aquarius plus holder BW

spectrus holder BW

Rear wall bracket, only for spectrus lights

spectrus	spectrus	spectrus twin
Recommended number of holders	1	1

Item code	Item
83020100	spectrus holder BW



spectrus holder BW

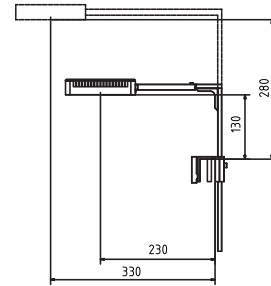

hopstop

Hop protection for open top aquaria

Helps prevent nocturnal fish from jumping out.
Content: 6 holders (combfix) and 3 plastic plates each app. 480 x 50 mm.

Item code	Item
418.12	hopstop



hopstop

food pipe

Food station for aquaria

- for feeding fish and corals
- prevents early loss of food via the drain
- with magnetic holder for easy attachment to an aquarium pane

Item code	Item
501.91	food pipe



Rust Protect

Rust Protect

Anti-corrosion and maintenance spray for metallic components

In aquarium cabinets with an open filter tank, wear and corrosion on the hinges caused by splashes and condensation can hardly be avoided. If used properly, the protective film applied by Rust Protect prevents moisture from reaching the metal parts, which significantly reduces the risk of corrosion. Rust Protect does not resinify and is resistant to saltwater.

- saltwater-resistant
- no draining
- no resinification
- wear reduction
- corrosion protection
- long-term effect

Regular use is recommended.

Item code	Item
599.950	Rust Protect, 100 ml



fishknob

fishknob

Attractive door-knobs

Item code	Item
511.10	fishknob Angel / pair
511.11	fishknob Discus / pair
511.12	fishknob Seahorse / pair

AB Reef Salt

Aquarium salt for all modern reef aquaria

Reef Salt is a dynamic new formulation, specifically designed for the needs of the modern reef aquarium. Reef Salt is blended from chemically pure raw materials, continuously quality controlled, achieves elevated levels of calcium and alkalinity reserve without resorting to harmful chelating agents, contains all the essential trace elements and enhanced levels of Strontium and Iodine, dissolves easily and leaves no residue.

Item code	Item
301.25	Reef Salt Nano 1.020 g can
301.10	Reef Salt 4 kg bucket
301.06	Reef Salt 20 kg bucket



Reef Salt

AB Reef Salt coral

Aqua Medic Reef Salt coral is a specially made high quality formulation suitable for all modern reef aquaria.

- contains vitamin B complex for the supply of corals with the vital vitamin B12 (according to scientific investigations)
- provides ideal nature-like conditions for growth and coloration of SPS and LPS corals
- with pH buffer and high calcium and magnesium content
- contains all the essential trace elements
- blended from chemically pure raw materials, continuously quality controlled
- dissolves easily and leaves no residue, so can be used quickly

Item code	Item
301.03	Reef Salt coral 20 kg bucket



Reef Salt coral

Aqua Medic seasalt

Synthetic seasalt for aquaria

Aqua Medic seasalt is a top quality product, fulfilling all the requirements of a modern synthetic seasalt. It is formulated from highly purified compounds, and contains a pH buffer and all the essential trace elements needed for saltwater aquaria. It dissolves quickly, leaving no residue, and can be used very shortly after being mixed. Its quality has been proven by its selection by numerous public aquaria, many leading wholesalers of saltwater fish, and thousands of coral reef and fish aquaria. It is the economic solution for large scale applications.

Item code	Item
300.00	Aqua Medic seasalt 20 kg bag



Aqua Medic seasalt



DensiMeter

Hydrometer to determine the density [g/ml] Tp. 25/4 °C in saltwater aquaria

Allow the hydrometer to float freely in sufficiently deep water for highly precise measurement, e.g. DensiTower. In this case, the water temperature of the sample should be, if possible, exactly 25 °C.

Maximum discrepancy at 25 °C: 0.001 g/ml

Measuring range: 1.018 to 1.028 g/ml

Resolution: 0.0001 g/ml

Dimensions: length app. 35.5 cm

Item code	Item
65905	DensiMeter



DensiTower

Hydrometer cylinder with overflow to determine the exact density by using a hydrometer (not included)

Fill the DensiTower to the top of the inner tube with the water to be tested, place the hydrometer into the water slowly. Excess water flows into the outer ring.

After use, remove the hydrometer and empty the DensiTower.

To determine the exact density, we recommend the use of Aqua Medic DensiMeter.

Ø app. 45 mm, height app. 355 mm

Item code	Item
65906	DensiTower



salimeter

Density meter (hydrometer)

salimeter is a density meter (hydrometer) allowing easy measurement of the specific gravity of saltwater in aquaria. salimeter has a measuring range of 1.000 to 1.040, with graduations at every 0.001 and an accuracy of ± 0.0005 at 25 °C (77 °F). Dimensions: length app. 27 cm, Ø app. 2 cm

Item code	Item
65900	salimeter

refractometer LED

Temperature compensating refractometer with LED illuminated scale for salinity determination

The refractometer is a precision optical instrument used to determine the salt concentration in saltwater aquaria. Its exact value can be determined in seconds and can be read either as absolute salt concentration (‰, ppt) or as specific density. When a beam of light enters the refractometer it is bent or "refracted" by the water in the test panel. This refraction is proportional to the salinity of the sample and can be directly read by viewing the internal scale. The integrated LED illumination provides good readability even in poor lighting conditions. Included in shipment: refractometer, a pipette for the water sample, a screw driver for calibration, desalinated water, LED display and a strong plastic box.



Item code	Item
65909	refractometer LED
65920-1	Test fluid 35 ppt for refractometer 60 ml



Tri Complex compact

Tri Complex compact

Complete solution for all reef aquaria

It is really important that corals receive a balanced ratio of calcium and all vital trace elements. Tri Complex compact was developed according to the latest research and helps offer optimal conditions for healthy and steady coral growth.

Features:

- no mixing necessary
- highly concentrated
- developed according to latest research results
- Calcium supply without ion shift
- helps reduce water changes
- including all vital trace elements
- optimum coral growth



Content:

- component blue: pH-buffer + iodine and fluorine complex
- component red: calcium, magnesium, strontium + vital elements

Item code	Item
353.100	Tri Complex compact 2 x 2 l
353.105	Tri Complex compact 2 x 5 l
353.130	Tri Complex compact 2 x 30 l

REEF LIFE System Coral

The complete solution for supplying reef aquaria with calcium and trace elements without ion shift.

The 3 component system consists of the following components:

- calcium (System Coral A) for increasing the calcium content
- KH Buffer (System Coral B) for increasing the carbonate hardness
- trace (System Coral C) provides essential trace elements

For each dosing spoon of KH Buffer, 2 ml of the other two components have to be added.

REEF LIFE System Coral A

Highly concentrated calcium additive for enhanced coral growth

Provides optimum calcium content in the aquarium that can be maintained simply with REEF LIFE System Coral Calcium.



REEF LIFE System Coral A

Item code	Item
350.001	REEF LIFE System Coral A Calcium 100 ml
350.010	REEF LIFE System Coral A Calcium 1.000 ml
350.050	REEF LIFE System Coral A Calcium 5.000 ml

REEF LIFE System Coral B KH BUFFER

Carbonate buffer stabilizes the pH value for a healthy aquarium

REEF LIFE System Coral B KH Buffer for increasing the alkalinity.

Item code	Item
351.001	REEF LIFE System Coral B KH Buffer 300 g/315 ml can
351.010	REEF LIFE System Coral B KH Buffer 1,000 g/1,000 ml can



REEF LIFE System Coral B KH BUFFER

REEF LIFE System Coral C Trace

Contains vital trace elements for fish, corals and invertebrates

Provides saltwater aquaria with vital trace elements such as boron, chrome, cobalt, copper, fluoride, iron, manganese, molybdenum and zinc.

REEF LIFE System Coral Trace does not contain any chelating agents.

Item code	Item
350.201	REEF LIFE System Coral C Trace 100 ml
350.202	REEF LIFE System Coral C Trace 250 ml
350.210	REEF LIFE System Coral C Trace 1,000 ml
350.250	REEF LIFE System Coral C Trace 5,000 ml



REEF LIFE System Coral C Trace

Kalkwasserpowder

For enhanced calcium supply during water top up

The addition of Kalkwasser has several positive effects on the water in a reef aquarium. The calcium level increases, the phosphate concentration is reduced by precipitation and the pH value increases. The growth of hair algae is decreased and the development of calcareous algae is encouraged.

Item code	Item
351.310	Kalkwasserpowder 350 g/1,000 ml can



Kalkwasserpowder



REEF LIFE Iodine

REEF LIFE Iodine

3 component iodine for healthy coral growth and bright colours

REEF LIFE Iodine is an iodide additive especially developed for saltwater aquaria. It supplies both fresh and saltwater aquaria with iodide and organic and elementary iodine. Whereas iodide and elementary iodine are immediately available for the animals and plants, the organic bond releases iodine slowly and ensures a long term supply. Iodine is an essential trace element for all invertebrates and especially for crustacea which require iodide to assist in sloughing off their shell. When provided with iodine, corals show better growth and more intense colouring.

Item code	Item
350.401	REEF LIFE Iodine 100 ml
350.402	REEF LIFE Iodine 250 ml
350.410	REEF LIFE Iodine 1,000 ml
350.450	REEF LIFE Iodine 5,000 ml



REEF LIFE Strontium

REEF LIFE Strontium

For healthy structure of skeleton of hard corals

REEF LIFE Strontium contains strontium ions in a form that can be easily assimilated by all invertebrates. It is essential for the production and the maintenance of the skeleton of hard corals, the shells of reef mussels and calcareous algae. In the sea, the strontium concentration is about 8 mg/l. There can be a lack of strontium in the aquarium if it isn't re-dosed regularly.

Item code	Item
350.501	REEF LIFE Strontium 100 ml
350.502	REEF LIFE Strontium 250 ml
350.510	REEF LIFE Strontium 1,000 ml
350.550	REEF LIFE Strontium 5,000 ml



REEF LIFE Magnesium

REEF LIFE Magnesium

For natural structure of skeleton of corals and calcareous algae

For regular supply of saltwater aquaria with normal magnesium need. For aquaria with heavy magnesium consumption, we recommend REEF LIFE Magnesium compact.

Item code	Item
350.601	REEF LIFE Magnesium 100 ml
350.602	REEF LIFE Magnesium 250 ml
350.610	REEF LIFE Magnesium 1,000 ml
350.650	REEF LIFE Magnesium 5,000 ml

REEF LIFE Magnesium compact

For natural structure of skeleton of corals and calcareous algae

Concentrated magnesium additive for saltwater aquaria.

Item code	Item
351.601	REEF LIFE Magnesium compact 250 g/315 ml can
351.610	REEF LIFE Magnesium compact 800 g/1,000 ml can



REEF LIFE Magnesium compact

REEF LIFE Calciumbuffer compact

To increase the calcium level and alkalinity

The perfect solution for calcium supply. The Calciumbuffer compact contains calcium and carbonate buffer in an optimum relation.

Item code	Item
351.101	REEF LIFE Calciumbuffer compact 250 g/315 ml can
351.110	REEF LIFE Calciumbuffer compact 800 g/1,000 ml can



REEF LIFE Calciumbuffer compact

Hydrocarbonat

Highly pure calcium carbonate

It is used in calcium reactors, calcite filters, bio filters and as substrate material in saltwater and Malawi/Tanganyikan aquaria. A natural calciumcarbonic acid equilibrium is created in all aquaria with an alkaline pH value and in a calcium reactor supplied with CO₂, the hydrocarbonate is completely dissolved to calcium bicarbonate. Hydrocarbonat is available in 3 grain sizes: fine (1 – 2 mm) for 'hardening' filters, medium (4 – 6 mm) for Calciumreactors, coarse (6 – 8 mm) as filter material.

Item code	Item
410.91-1	Hydrocarbonat 1 l can fine (app. 0.25 gal)/1 kg
410.91-2	Hydrocarbonat 1 l can medium (app. 0.25 gal)/1 kg
410.91-3	Hydrocarbonat 1 l can coarse (app. 0.25 gal)/1 kg
410.92-1	Hydrocarbonat 5 l bucket fine (app. 1.3 gal)/8 kg
410.92-2	Hydrocarbonat 5 l bucket medium (app. 1.3 gal)/8 kg
410.92-3	Hydrocarbonat 5 l bucket coarse (app. 1.3 gal)/8 kg
410.90-1	Hydrocarbonat bag/25 kg fine
410.90-2	Hydrocarbonat bag/25 kg medium
410.90-3	Hydrocarbonat bag/25 kg coarse



Hydrocarbonat

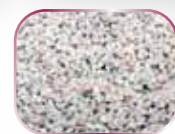

fine



medium



coarse



Aqua Medic Bali Sand



Aqua Medic Bali Sand

- high-quality white substrate
- natural product, without additives
- supports the biodegradation of Detritus
- suitable for use in all saltwater aquaria

Aqua Medic Bali Sand is a very pure limestone that consists of about 98% of calcium carbonate as well as some zeolite-like minerals. Aqua Medic Bali Sand, like the coral reef, is a fossil natural material and is not removed from the oceans. This substrate is an alternative, producing the optimal biological effect for all aquarium inhabitants and preserving nature.

Item code	Item
420.30-1	Aqua Medic Bali Sand 0,5 – 1,2 mm, 5 kg (11 lbs) bag
420.30-2	Aqua Medic Bali Sand 2 – 3 mm, 5 kg (11 lbs) bag
420.30-3	Aqua Medic Bali Sand 3 – 4 mm, 5 kg (11 lbs) bag NEW
420.31-1	Aqua Medic Bali Sand 0,5 – 1,2 mm, 10 kg (22 lbs) bag
420.31-2	Aqua Medic Bali Sand 2 – 3 mm, 10 kg (22 lbs) bag
420.31-3	Aqua Medic Bali Sand 3 – 4 mm, 10 kg (22 lbs) bag NEW



Aqua Medic Tonga Pearls

Aqua Medic Tonga Pearls

Pure, environmentally friendly substrate

Tonga Pearls is a very pure substrate made under controlled conditions. Produced lime material that consists of calcium carbonate of around 99%. Tonga Pearls is neither a fossil natural product nor is the material extracted from the sea. This resource-saving, new substrate has a corresponding crystal structure to natural coral sand so an optimal alternative. It also provides a suitable biological effect for all aquarium dwellers.

Item code	Item
420.40-1	Aqua Medic Tonga Pearls, 5 kg (11 lbs) bag
420.41-1	Aqua Medic Tonga Pearls, 10 kg (22 lbs) bag

plancto

Concentrated food for corals and invertebrates

plancto is a pH stabilized, high-quality concentrated food for the nutrition of plankton and saltwater invertebrates. Its unique composition and its particle size of 25 – 200 µm makes it especially suitable for plankton feeders. It is also an excellent single food source for rearing artemia. The inclusion of high taste elements results in visible stimulation of feeding tentacles to encourage high nutrient take up. Even if overdosed it is impossible to effect the animals digestive systems.

Item code	Item
340.001	plancto 100 ml
340.002	plancto 250 ml
340.010	plancto 1,000 ml
340.050	plancto 5,000 ml



plancto

aquabiovit

Vital vitamins for fish and invertebrates

aquabiovit is a multi vitamin compound for use in fresh and saltwater. Its formulation is suited to both, fish and invertebrates. Its regular use enhances growth, strengthens the immune system and increases the willingness to spawn.

Item code	Item
342.001	aquabiovit 100 ml
342.002	aquabiovit 250 ml



aquabiovit

aminovit

Contains all vital amino acids and vitamins

Amino acid concentrate for coral reef aquaria. Additional food for invertebrates, in particular for LPS, but also for gorgonians, tube worms and sponges. The animals ingest directly – the colours improve and the tissue growth is accelerated. aminovit is also ideal for enriching the dry or frozen food. Or soak the food in an equivalent quantity prior to feeding.

Item code	Item
342.102	aminovit 250 ml



aminovit



coral fit

coral fit

Coral food

coral fit is a natural coral food suitable for SPS, LPS and soft corals. coral fit contains shell-less artemia eggs and is easily absorbed by corals.
Content: app. 210 g

Item code	Item
343.000	coral fit 210 g



pipette 35

pipette 35

Pipette

The pipette is the ideal choice for precise feeding of fish and corals. Medications can also be dosed selectively.
Length: app. 35 cm

Item code	Item
39040	pipette 35



pipette 60

pipette 60

Pipette

The pipette is the ideal choice for precise feeding of fish and corals. Medications can also be dosed selectively.
Length: app. 60 cm

Item code	Item
39041	pipette 60

ALGAL RESOURCES



NO3 reduct

NO3 reduct

Nitrat + Phosphat control

NO3 reduct contains organic compounds that serve bacteria as an additional carbon source and thus stimulate greater reproduction. These bacteria are used by corals as food or are skimmed off. Previously absorbed nutrients disappear with them, so that the nitrate and phosphate content of the water gradually decreases. The corals use the bacteria as additional food that leads to an improvement in colour and polyp extension.

Item code	Item
411.80	NO3 reduct 500 ml

aqua + GH

Increases the total hardness of aquarium water

aqua + GH increases the total hardness in freshwater aquaria. In connection with aqua + KH you can produce from reverse osmosis water or too soft water suitable water for fishes and plants.

Item code	Item
123.001	aqua + GH 250 g can



aqua + GH

aqua + KH

Increases the carbonate hardness of aquarium water

Through a correct adjusted carbonate hardness you could avoid harmful pH up- and downturns. By using aqua + KH the pH level could be stabilized and the carbonate hardness could be increased. In combination with aqua + GH you can produce from reverse osmosis water fish and plant suitable water.

Item code	Item
123.101	aqua + KH 300 g can



aqua + KH

aqualife + Vitamine

High effective water treatment preparation for freshwater aquaria

Tap water often contains heavy metal and chlorine that harms the fishes, it causes diseases and symptoms of poisoning. aqualife + Vitamine contains suitable chelates and reducer that binds the harmful substances respectively transfers it in harmless compounds. Special protective colloids that have been approved since many years, strengthens the protective function of the mucosa and keep the sensitive craw/intestinal tract of the animals from damages. Useful vitamins improve the body's defences of the fishes and enhance their well-being.

Item code	Item
120.001	aqualife + Vitamine 100 ml
120.002	aqualife + Vitamine 250 ml
120.010	aqualife + Vitamine 1,000 ml
120.050	aqualife + Vitamine 5,000 ml



aqualife + Vitamine

ferreal + spureal

Intensive iron fertilizer for freshwater aquaria

ferreal + spureal is a combination compound. It contains beside iron more essential micro elements such as manganese, molybdenum, boron, zinc and cobalt. ferreal + spureal prevents with continuous application reduced growth, the yellowing of the leafs and strengthens the plants. The colours of the plants become an intensive glow.

Item code	Item
121.001	ferreal + spureal 100 ml
121.002	ferreal + spureal 250 ml
121.010	ferreal + spureal 1,000 ml
121.050	ferreal + spureal 5,000 ml



ferreal + spureal



floreal + iod

floreal + iod

High effective compound fertilizer for freshwater aquaria

floreal + iod is an indispensable instrument to ferreal + spureal that adjust the mineral balance of the plants and beyond supplies them with iodine and fluo-rine. Through this the growth of the plants will be increased. Furthermore iodine increases the vitality and the willingness to spawn of the fish. The contained iodine will be released slowly over several days whereby it is continued available.

Item code	Item
122.001	floreal + iod 100 ml
122.002	floreal + iod 250 ml
122.010	floreal + iod 1,000 ml
122.050	floreal + iod 5,000 ml

PLANKTON



aquabreed complete

aquabreed complete

Artemia cultivation unit

A cultivation unit for hatching larger quantities of artemia cysts. The unit can be installed inside or outside of the aquarium if positioned in a warm environment. The hatch time depends on the ambient temperature. Capacity app. 2,000,000 cysts per hatch. After about 2 weeks, the animals are fully grown and can be used as food. The unit may also be used for the breeding of artemia.

A stable wall holder and a pump for ventilation are included. A drain valve with a large diameter prevents clogging during emptying. The optimal installed outlet valve allows a measured removal of hatched artemia whilst the shells remain in the culture unit. The push to open lid makes filling the hatchery easier.

Contents: aquabreed complete reactor (app. volume 1 litre), support plate Ø app. 8 cm (app. 3.24")

Length: app. 52 cm (app. 17")

Hose connection: 6 mm (app. 1/4"), air pump Mistral 100

Item code	Item
35020	aquabreed complete



plankton reactor

plankton reactor

Zooplankton cultivation unit

Many species of salt- and freshwater zooplankton can be cultivated in the plankton reactor. The zooplankton is fed with micro-algae from the plankton light reactor. The zooplankton has great growth potential: under optimal algal nutrition the number of rotifers (Brachionus) may double over four days. Brachionus is the ideal food for raising many saltwater fish larvae and invertebrates in the saltwater aquarium. Contents: plankton reactor app. volume 2.5 litre (app. 0.65 gal), wall bracket and connections for air pump. Ø 8 cm (app. 3.2"). Length: 80 cm (app. 32"). Hose connection: 6 mm (app. 1/4")

Item code	Item
35005	plankton reactor

plankton light reactor II

Cultivation unit for plankton breeding

The plankton light reactor II has a volume of approx. 5 l. A simple system for producing plankton in the natural food chain. Within the plankton light reactor II, microalgae are cultivated using light, fertilizer, and the carbon dioxide content of the air. These can be fed directly to many filter-feeding invertebrates, or used to breed zooplankton. The integrated 10 W LED light provides sufficient light for a good breeding rate. If the nutrient content is sufficient, the mass of the algae can quadruple in 24 hours. The plankton light reactor II is equipped with two connections for the simultaneous supply of air and CO₂. If there is a high demand for plankton, the CO₂ content can be increased by pH control. There is a holder for a pH probe in the lid. With normal requirements, however, additional CO₂ is not required.

For easy partial removal of plankton, there is a hose with dosing clamp and holder on the housing's lid. Saltwater or freshwater algae, phytoplankton and zooplankton can be cultivated. For ventilation, we recommend our air pump Mistral 100 or larger types.

Technical data:

- Ø app. 150 mm
- total height: app. 560 mm incl. light
- hose connection: 2 x 4/6 mm
- LED light app. 10 W
- incl. hose with dosing clamp

Item code	Item
35010	plankton light reactor II



plankton light reactor II

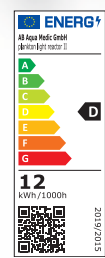



Titan 2200

Titan 200

Titan

Titan	200	600	1600	2200
For aquaria up to (l)	250	750	1,500	2,500
Compressor power (PS)	0.1	0.25	0.5	1
Power supply	220 – 240 V / 50 Hz			
Power uptake (w)	160	345	480	550
Cooling power (w)	200	600	800	1,600
Recommended water flow (l/h) app.	250 – 1,200	1,000 – 2,500	1,200 – 3,000	1,500 – 4,000
Connections	1/2" or 5/8"	3/4"	3/4" or 1"	1" or 1 1/4"
Hysteresis	1°			
Housing material	PVC / ABS			
Heat exchanger material	Titanium			
Cooling gas	R134a			
Dimensions mm (l x w x h) app. (incl. connection)	430 x 250 x 470	460 x 320 x 520	480 x 350 x 570	550 x 390 x 630
Weight (kg) app.	13.0	19.9	22.7	30.2

Item code	Item
105.020	Titan 200
105.060	Titan 600
105.160	Titan 1600
105.220	Titan 2200



arctic breeze 2-pack



arctic breeze 4-pack



arctic breeze 6-pack

arctic breeze

Silent long life fans, with real ball bearing and brush free motor. 12 V low voltage with adjustable transformer (3 – 12 V) for speed control. By this, the cooling power can be adjusted. High capacity fans, adjustable from 80,000 l/h (double unit at 12 V) to 240,000 l/h (6 fold unit at 12 V). Power uptake only 0.5 – 3 W per fan.

arctic breeze aquarium fans can easily be fixed at the aquarium frame. It cools down the water by increasing the evaporation. The complete construction is made from corrosion proof plastic and aluminium.

For temperature-dependent control we recommend optional the use of our T controller twin.

Dimensions (l x w x h):

arctic breeze 2-pack: app. 16 x 4 x 15 cm

arctic breeze 4-pack: app. 28 x 4 x 15 cm

arctic breeze 6-pack: app. 40 x 4 x 15 cm

Item code	Item
107.102	arctic breeze 2-pack
107.104	arctic breeze 4-pack
107.106	arctic breeze 6-pack

Titan Professional

For heating and cooling

Titan Professional	4000	6000	8000	15000
Dimensions (l x w x h) mm app.	740 x 410 x 740	740 x 410 x 740	750 x 460 x 750	850 x 550 x 980
Net weight (kg) app.	73	78	92	150
Power supply (V)	220 – 240 V/50 Hz			380 V; 3 Ph./50 Hz
Cooling capacity (W) app.	3,800	5,200	7,200	14,900
Heating capacity (W) app.	3,800	5,200	7,200	14,900
Compressor power (HP)	1.5	2	3	5
Power uptake cooling (kW) app.	1.25	1.78	2.34	4.9
Power uptake heating (kW) app.	1.08	1.40	1.75	3.92
Recommended fuse protection (A)	16	16	16	32
Rated current consumption (A) app.	6.5	9.8	12.5	9.1
Recommended flow rate (l/h)	3,000 – 10,000	4,000 – 12,000	6,500 – 16,000	10,000 – 32,000
For aquaria up to (l)				
$\Delta T = 5\text{ }^{\circ}\text{C}$	4,000	6,000	8,000	15,000
$\Delta T = 10\text{ }^{\circ}\text{C}$	2,000	3,000	4,000	7,500
Cooling agent and cooling quantity (g) app.	R410A – 1,180 g	R410A – 1,080 g	R410A – 1,300 g	R410A – 3,100 g
Heat exchanger	Titanium			
Diameter water in-outlet	1 1/2" / 50 mm			
Ambient temperature app.	5 °C – 38 °C			
Temperature control range app.	5 °C – 35 °C			
Max. water pressure	≤ 0,2 bar			
Hysteresis	1 °C			
Housing material	X5CrNiMo 17-12-2 (corrosion-resistant steel (V4A))			



Titan 6000 Professional

Item code	Item
108.040	Titan 4000 Professional
108.060	Titan 6000 Professional
108.080	Titan 8000 Professional
108.150	Titan 15000 Professional

Larger cooling units on demand!

Titanium Heater

Titan Aquarium Heater

Titanium heaters are the safe alternative to glass heaters in both fresh- and saltwater aquaria. The unbreakable titanium housing is saltwater resistant and the heaters have both overheat and dry running protection cutouts. The heaters must be used in combination with a temperature controller. For temperature-dependent control we recommend optional the use of our T controller twin. Ø 20 mm

Item code	Item
110.010	Titanium heater 100 W, for aquaria up 100 – 250 l, length: app. 27 cm (app. 10.6")
110.020	Titanium heater 200 W, for aquaria up 250 – 500 l, length: app. 28 cm (app. 11")
110.030	Titanium heater 300 W, for aquaria up 500 – 1,000 l, length: app. 30 cm (app. 11.8")
110.050	Titanium heater 500 W, for aquaria up 1,000 – 1,500 l, length: app. 32 cm (app. 12.6")



Titanium Heater



micro heater

micro heater

Adjustable heater with USB connection for smaller aquaria

The micro heater is suitable for small aquaria with a maximum water volume of 10 l. The micro heater can be flexibly positioned using the bracket supplied. Intelligent electronics keep the water in the aquarium at the set temperature. The micro heater is equipped with overheating and dry-running protection. The external controller with display makes it easy to set the desired water temperature. You can choose between Celsius and Fahrenheit.

	micro heater
For aquaria up to	10 l
Voltage	5 V
Power consumption app.	10 W
Cable length app.	130 cm
Temperature accuracy	+/- 1°C / +/- 1°F
Adjustment range	18 °C – 34 °C / 64 °F – 93 °F
Control steps	0,5 °C / 1 °F
Dimensions app.	Ø 20 mm, L 55 mm (no bracket)

Caution:

A 5 V, min. 2.4 A, USB power pack is required for the micro heater (not included in delivery).

Item code	Item
110.001	micro heater NEW



T controller twin

T controller twin

Digital temperature monitor and controller, for the control and monitoring of heating systems and cooling units simultaneously

The temperature controller T controller twin is used for controlling both heating systems and cooling units. Measuring and switching accuracy is 0.1°C. The control range varies from 16 – 40°C, and the set value is in 0.1 °C increments. **The maximum load for heating systems is 1,200 watts and 460 watts for cooling units.** Because of the integrated double socket it is possible to connect a heating system and cooling unit simultaneously. The T controller twin is supplied with a waterproof temperature probe. The LCD display provides instant information on the current temperature. The minimum and maximum values can be easily adjusted. (IP65)

Item code	Item
200.25	T controller twin

heat controller duo II

Digital temperature monitor and controller, for controlling and monitoring of under gravel heater and other heating systems

The temperature controller heat controller duo II is used for controlling heaters and under gravel heating systems at the same time. Measuring and switching accuracy is 0.1 °C. The control range varies from 0 – 50 °C, the set value is in 0.1 °C increments and is controlled exactly to 1 °C. The maximum load for the heating systems and under gravel heater is 1,200 watts. Because of the integrated double socket it is possible to connect a heater and an under gravel heating system simultaneously.

The heat controller duo II is supplied with a temperature probe attached. The LCD display provides instant information on the current temperature, time and state of the connected units. The heating cable is controlled by a timer, the on/off time can be programmed. If the set value is not reached, the under gravel heater is switched on. To avoid overheating, both sockets switch off as soon as the set value is reached.

Item code	Item
200.32	heat controller duo II



heat controller duo II



cool control

Digital temperature monitor and controller, for the control and monitoring of fans

The temperature controller cool control with touch screen display is used for controlling 12 or 24 volt fans with coaxial connectors (5.5 mm x 2.1 mm). The switching accuracy is 0.5 °C. The control range varies from 0 – 36 °C, and the set value is in 0.1 °C increments. The cool control is supplied with a waterproof temperature probe. The LCD display provides instant information on the current temperature. The set value and fan power (40 – 99%) are also displayed and can be easily adjusted.

- high and reliable switching accuracy
- maximum switching power: 65 W
- dimensions: l x w x h app. 120 x 62 x 28 mm
- cable length power supply to the fan: 150 cm
- cable length temperature sensor: 100 cm

Item code	Item
200.26	cool control



cool control





EcoDrift x.3



Power Diffusor



EcoDrift x.3
Controller



EcoDrift x.3

High-performance current pump with App-control for adjusting the flow rate and wave frequency

- “ultra silent“ due to optimized control electronics
- incl. controller
- control and programming via App (iTunes and Google Playstore) or manually via the controller
- simultaneous control of several pumps possible
- multiprogramming of pumps via master-slave or cross-flow possible
- different flow patterns can be set
- performance increase of up to 10% thanks to plug-on power diffuser
- magnetic holder with vibration-reducing rubber dampers; variable flow direction
- 0 – 10 V connection for external control options
- 24 V safety tension, incl. transformer 100 – 240 V / 50 – 60 Hz

EcoDrift	EcoDrift 4.3	EcoDrift 8.3	EcoDrift 15.3	EcoDrift 20.3
For aquaria up to	300 l	800 l	1,500 l	2,000 l
Capacity adjustable	up to 4,000 l/h	up to 8,000 l/h	up to 15,000 l/h	up to 20,000 l/h
Power consumption	3 – 10 watts	8 – 20 watts	10 – 35 watts	20 – 60 watts
Power supply	100 – 240 V/50 – 60 Hz			
Dimensions, app.	80 mm, Ø 70 mm	105 mm, Ø 85 mm	136 mm, Ø 110 mm	146 mm, Ø 110 mm
Magnet holder for glass thickness up to	15 mm	15 mm	15 mm	15 mm

Item code	Item
103.804	EcoDrift 4.3
103.808	EcoDrift 8.3
103.815	EcoDrift 15.3
103.820	EcoDrift 20.3

SmartDrift x.1

Compact “ultra silent” current pump with App-control for adjusting the flow rate and wave frequency

- control and programming via App (iTunes and Google Playstore) or manually via the controller
- simultaneous control of several pumps possible
- multiprogramming of pumps via master-slave or cross-flow possible
- different flow patterns can be set
- new flow pattern due to innovative impeller technology ensures extreme smooth running
- polished ceramic shaft and bearings for quiet operation and low maintenance
- power-saving D/C motor 24 V, high efficiency
- 0 – 10 V connection for external control options
- 24 V safety tension, incl. transformer 100 – 240 V / 50 – 60 Hz

SmartDrift	SmartDrift 3.1	SmartDrift 7.1	SmartDrift 11.1
For aquaria up to	300 l	800 l	1,500 l
Capacity adjustable	up to 4,600 l/h	up to 10,500 l/h	up to 16,000 l/h
Power consumption	3 – 15 watts	8 – 25 watts	10 – 35 watts
Power supply	100 – 240 V/50 – 60 Hz		
Dimensions, app.	55 mm, Ø 65 mm	65 mm, Ø 75 mm	70 mm, Ø 85 mm
Magnet holder for glass thickness up to	10 mm	12 mm	15 mm

Item code	Item
103.203	SmartDrift 3.1
103.207	SmartDrift 7.1
103.211	SmartDrift 11.1



SmartDrift x.1



ULTRA SILENT



30°



SmartDrift x.1 Controller









extension cord DC Runner/EcoDrift

extension cord DC Runner/EcoDrift

For cable extension between pump and controller

Suitable for DC Runner/Eco Drift x.1, x.2 and x.3.

Please note: Only one extension cord per controller may be used. If several extension cables are connected to a controller, a proper function cannot be guaranteed.

Item code	Item
100.301	extension cord DC Runner/EcoDrift 1.8 m



connection cord DC 0 – 10 V

connection cord DC 0 – 10 V

Connection cable 0 – 10 V

Connection cable to connect DC-Controller to a 0–10V controller

suitable for:

- EcoDrift x.1 series
- EcoDrift x.2 series
- DC Runner x.1 series
- DC Runner x.2 series

length: app. 200 cm

Item code	Item
100.302	connection cord DC 0 –10 V

DC Runner 400/600/800/1000

Universal pump for aquaria

- “ultra silent” due to optimized control electronics
- for use as a circulation or current pump in salt or freshwater aquaria
- rugged pump housing
- power-saving D/C motor 24 V, high efficiency
- polished ceramic shaft and bearings for quiet operation and low maintenance for many years
- only submerged use is possible
- incl. transformer 24 V



DC Runner 1000



DC Runner 800

DC Runner	400	600	800	1000
Power supply pump	24 V			
Power supply transformer	100 – 240 V / 50 – 60 Hz			
Pump power	up to 450 l/h	up to 600 l/h	up to 800 l/h	up to 1,000 l/h
Max. head	up to 1.4 m	up to 1.7 m	up to 1.2 m	up to 1.5 m
Power consumption	max. 6 watts	max. 8 watts	max. 10 watts	max. 15 watts
Connection pressure side	13 mm	13 mm	12 / 16 / 19 mm	12 / 16 / 19 mm
Pre-filter basket	✓	✓	✓	✓
Hose connections pressure side	✓	✓	✓	✓
Screw joints pressure side	–	–	✓	✓
Protection rating	IP X8			
Dimensions in mm app. l x w x h (incl. basket)	87 x 43 x 58	87 x 43 x 58	120 x 56 x 82	120 x 56 x 82
Dimensions in mm app. l x w x h (without basket)	64 x 43 x 58	64 x 43 x 58	95 x 56 x 82	95 x 56 x 82

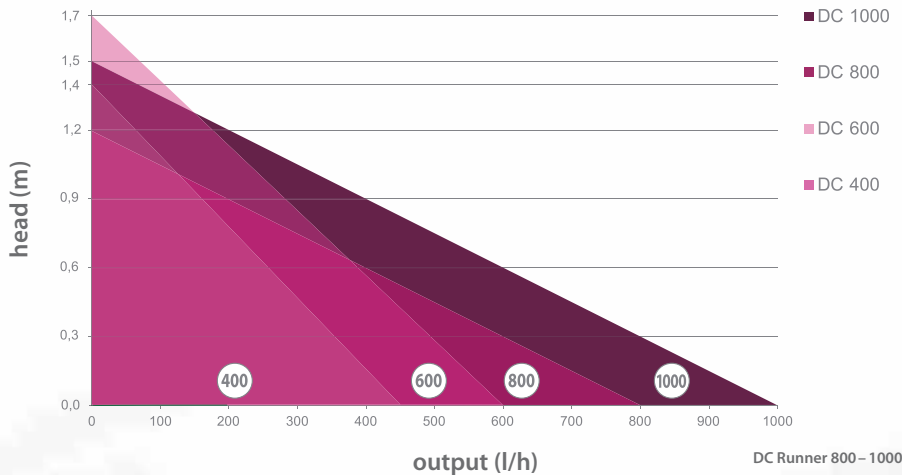

DC Runner 800 – 1000

Item code	Item
102.004	DC Runner 400
102.006	DC Runner 600
102.008	DC Runner 800
102.010	DC Runner 1000



DC Runner x.3

Powerful, adjustable universal pumps with App-control for aquaria

- “ultra silent” due to optimized control electronics
- for use as a circulation or current pump in salt or freshwater aquaria
- control and programming via App (iTunes and Google Playstore) or manually via the controller
- incl. controller
- simultaneous control of several pumps possible
- 24 hour performance can be programmed
- 0 – 10 V connection for external control options
- rugged pump housing
- power-saving D/C motor 24 V, high efficiency
- polished ceramic shaft and bearings for quiet operation and low maintenance for many years
- submerged and non-submerged use is possible



DC Runner	1.3	2.3	3.3	5.3	9.3
Power supply pump	24 V				
Power supply transformer	100 – 240 V / 50 – 60 Hz				
Pump power	up to 1,200 l/h	up to 2,000 l/h	up to 3,000 l/h	up to 5,000 l/h	up to 9,000 l/h
Max. head	up to 1.5 m	up to 2.2 m	up to 2.7 m	up to 3.5 m	up to 4.8 m
Power consumption	max. 12 watts	max. 20 watts	max. 25 watts	max. 50 watts	max. 65 watts
Connection suction side	25 mm / 1 inch	25 mm / 1 inch	32 mm / 1¼ inch	32 mm / 1¼ inch	40 mm / 1½ inch
Connection pressure side	20 mm / 0,8 inch	25 mm / 1 inch	25 mm / 1 inch	32 mm / 1¼ inch	40 mm / 1½ inch
Pre-filter basket	✓	✓	✓	✓	–
Hose connections	–	✓	✓	✓	✓
Screw joints	–	✓	✓	✓	✓
Protection rating	IP X8				
Dimensions in mm app. L x w x h (incl. basket)	125 x 60 x 85	140 x 68 x 100	195 x 90 x 115	190 x 95 x 125	–
Dimensions in mm app. x w x h (without basket)	90 x 60 x 85	105 x 68 x 100	145 x 90 x 115	170 x 95 x 125	180 x 95 x 135

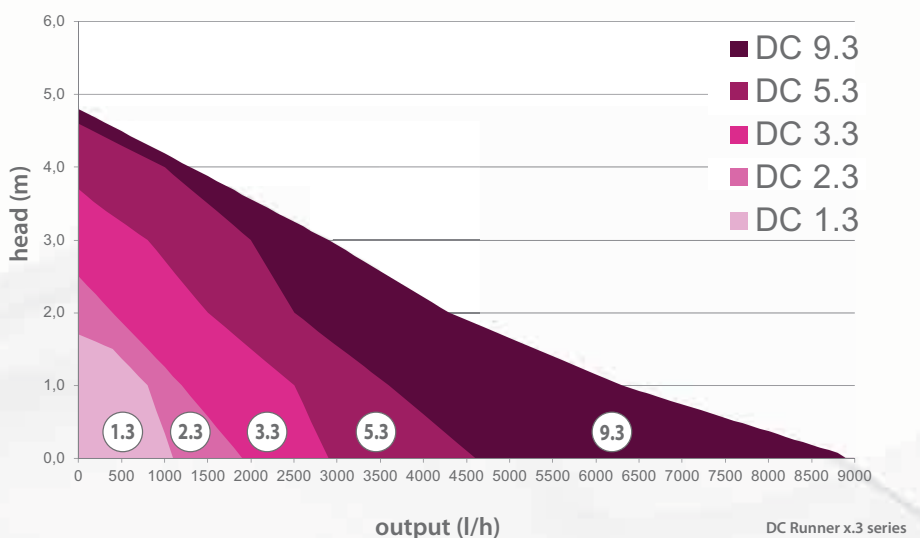

Item code	Item
100.813	DC Runner 1.3
100.823	DC Runner 2.3
100.833	DC Runner 3.3
100.853	DC Runner 5.3
100.893	DC Runner 9.3

extension cord DC Runner/EcoDrift

For cable extension between pump and controller

Suitable for DC Runner/Eco Drift x.1, x.2 and x.3.

Please note: Only one extension cord per controller may be used. If several extension cables are connected to a controller, a proper function cannot be guaranteed.



extension cord DC Runner/EcoDrift

Item code	Item
100.301	extension cord DC Runner/EcoDrift 1.8 m

connection cord DC 0 – 10 V

Connection cable 0 – 10 V

Connection cable to connect DC-Controller to a 0–10 V controller

suitable for:

- EcoDrift x.1 series
- EcoDrift x.2 series
- DC Runner x.1 series
- DC Runner x.2 series

length: app. 200 cm



connection cord DC 0 – 10 V

Item code	Item
100.302	connection cord DC 0 –10 V



AC Runner 9.2



AC Runner x.2 series



AC Runner x.2

Powerful universal pump for aquaria

220 V – 240 V / EU-Plug only

- for use as a circulation or current pump in salt or freshwater aquaria
- rugged pump housing
- polished ceramic shaft and bearings for quiet operation and low maintenance
- submerged and non-submerged use is possible
- including prefilter basket and hose connections (AC Runner 3.2 + 5.2)
- including hose connections (AC Runner 9.2 + 12.2)

AC Runner	3.2	5.2	9.2	12.2
Pump power - l/h	up to 3,000	up to 5,000	up to 9,000	up to 12,000
Max. head	up to 2.7 m	up to 4.2 m	up to 5 m	up to 5.5 m
Total power consumption	max. 27 W	max. 44 W	max. 78 W	max. 92 W
Power supply pump	220 V – 240 V / 50 Hz			
Suction side Ø	32 mm/ 1 1/4 inch	32 mm/ 1 1/4 inch	40 mm/ 1 1/2 inch	40 mm/ 1 1/2 inch
Pressure side Ø	25 mm/ 1 inch	32 mm/ 1 1/4 inch	40 mm/ 1 1/2 inch	40 mm/ 1 1/2 inch
Protection rating	IP X8			
Dimensions in mm (l x w x h), app.	155 x 90 x 115 (195 x 90 x 115)	175 x 105 x 125 (195 x 105 x 125)	195 x 115 x 130 (basket not included)	195 x 115 x 130 (basket not included)

Dimensions are indicated without fittings / dimensions within brackets mean including basket

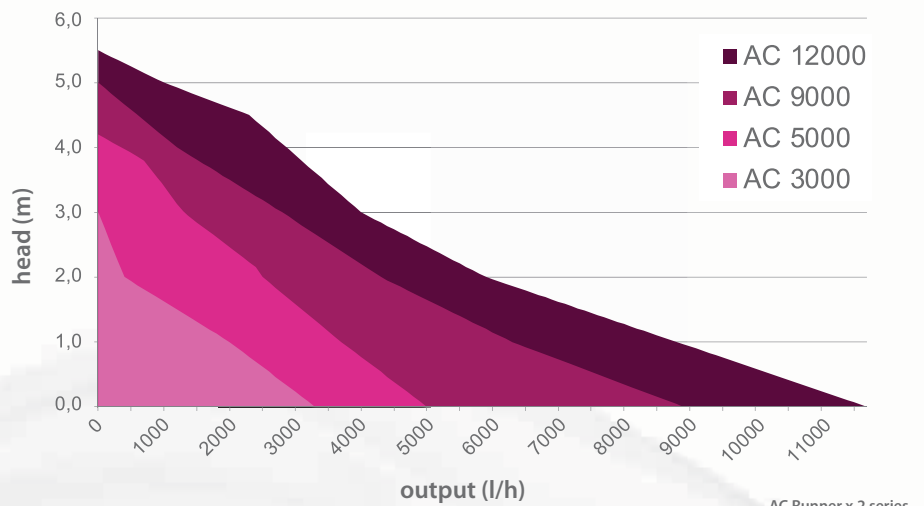

Item code	Item
100.432	AC Runner 3.2
100.452	AC Runner 5.2
100.492	AC Runner 9.2
100.522	AC Runner 12.2

AM PRO

Circulation pump

The circulation pumps in the AM PRO series are powerful with high performance. They have low energy consumption and operate at a low decibel volume. Minimal maintenance is necessary. The AM PRO pumps have a plastic housing. The axle is sealed with a mechanical seal. The pumps must be dry mounted.

Features:

- asynchronous, two-pole motor
- protection type IP X5
- integrated overload protection
- highly effective cooling element for optimal heat dissipation
- not self-extracting

AM PRO	50	75	100
Power (KW) app.	0.55	0.75	0.90
Power (PS) app.	0.50	0.75	1.00
Power consumption (A) app.	2.5	3.5	4.7
Power supply	220 – 230 V / 50 Hz		
Protection rating	IP X5		
Sound level (dB) app.	60	60	65
Connections suction and pressure side	1.5" / 50 mm	1.5" / 50 mm	1.5" / 50 mm
Weight (kg) app.	7.3	8.2	9.1
Dimensions (l x w x h) mm, app.	375 x 154 x 258		

Flow rate	AM PRO 50	AM PRO 75	AM PRO 100
m ³ /h at 2 m pumping head	13.2	14.4	17.0
m ³ /h at 4 m pumping head	10.3	11.3	13.6
m ³ /h at 6 m pumping head	6.6	8.6	9.8
m ³ /h at 8 m pumping head	1.0	4.0	5.1

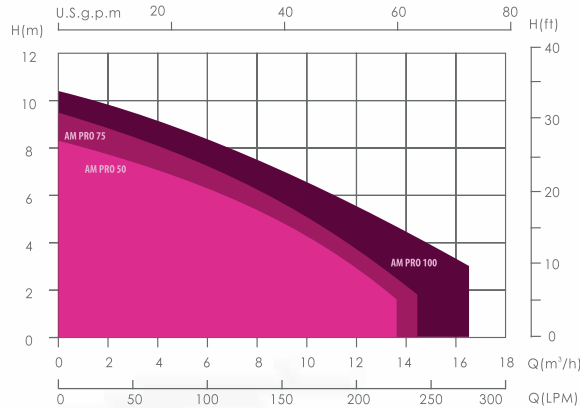

AM Pro series

Item code	Item
401.050	AM PRO 50
401.075	AM PRO 75
401.100	AM PRO 100
401.051	motor protection switch pump AM PRO 50
401.076	motor protection switch pump AM PRO 75
401.101	motor protection switch pump AM PRO 100

A motor protection switch is necessary for the operation of the pump. The guarantee is void, if the pump is used without a motor protection switch.

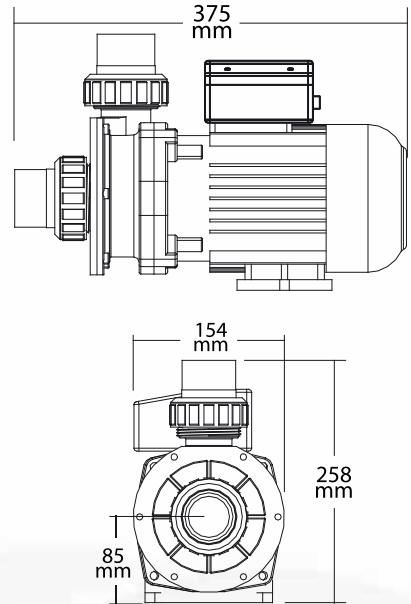



Mistral series



Mistral

Membrane air pumps for aquaria

The air pumps of the Mistral series are characterized by very low power consumption and a durable membrane. The vibration-absorbing rubber feet ensure low-noise and low-vibration operation. The Mistral 400 and 800 have an adjustable power regulator that allows flexible use for ventilating aquaria with air stones and the operation of protein skimmers with ceramic or wooden air stones. As a result, the Mistral membrane air pumps are designed for use in freshwater and saltwater aquaria in home living areas.

Mistral	100	400	800
Voltage	220 – 240 V~/50 Hz		
Max. power uptake app.	2 watts	5 watts	12 watts
Max. capacity	80 l/h	2 x 180 l/h	4 x 180 l/h
Connection pressure side	Air hose 4/6 mm		
Number of connections	1	2	4
Adjustable	–	✓	✓
Weight app.	125 g	445 g	1,260 g
Housing material	plastic		
Dimensions (l x w x h) app.	90 x 45 x 47 mm	153 x 75 x 66 mm	196 x 165 x 89 mm

Included in shipment:

Mistral	100	400	800
Air hose, length 50 cm, Ø 4/6 mm	–	✓	✓
Connection 2 to 1, 2 x Ø 4/6 mm to 1 x Ø 4/6 mm	–	✓	–
Connection 4 to 1, 4 x Ø 4/6 mm to 1 x Ø 6/8 mm	–	–	✓

Item code	Item
101.011	Mistral 100
101.041	Mistral 400
101.081	Mistral 800

Mistral II

Powerful diaphragm air pumps for aquaria

This family of powerful diaphragm air pumps has a cast aluminium housing to ensure long life and silent operation. The special membrane guarantees for a long life, with built-in air filter. They are ideally suited for supplying air lift filters, air stones and protein skimmers using either ceramic or wooden air diffusers.

Mistral	2000 II	4000 II
Power requirements	220 – 240 V~/50 Hz	
Power uptake	20 watts	38 watts
Maximum capacity	2,100 l/h	3,900 l/h
Capacity at 1 m (3 ft) depth (100 mbar, 1.45 psi)	1,200 l/h (300 gph)	2,400 l/h (600 gph)
Maximum pressure	> 280 mbar (4.04 psi)	> 350 mbar (5.05 psi)
Connection pressure side	air tube 12 mm (½")	
Cable length	app. 1.8 m	
Weight	2.7 kg (app. 5.95 lbs)	3.4 kg (app. 7.50 lbs)
Housing	cast aluminium	
Dimensions (l x w x h), app.	19.2 x 12.0 x 14.6 cm	20.8 x 13.5 x 18.0 cm



Mistral 2000 II

Mistral 4000 II



Item code	Item
101.201	Mistral 2000 II
101.401	Mistral 4000 II



reefdoser EVO 1/3/5

Calibratable dosing pump with App-control

In the case of the Aqua Medic reefdoser EVO series 1, 3 and 5, the integrated dosing pumps can be controlled individually. Dosing is done manually or automatically. Each channel can be calibrated individually and separately. The interval control, which can be operated via the app, allows a wide range of settings – from one-second to daily.

- App-control allows a wide range of dosing scenarios
- flexible installation with wall bracket or stand
- active signal LED when the pump is working
- control panel with touch sensors
- integration of further reefdoser EVO 1, 3 or 5 possible via App

Application examples:

- regular dosing of liquids, e.g. trace elements and fertilizers
- calcium and hydrogen carbonate addition in coral reef aquaria
- addition of lime water
- automatic feeding with live plankton

reefdoser EVO	1	3	5
Dimensions (l x w x h), app.	97 x 105 x 127 mm	197 x 105 x 127 mm	277 x 105 x 127 mm

Item code	Item
104.201	reefdoser EVO 1
104.203	reefdoser EVO 3
104.205	reefdoser EVO 5

Options:

104.144-31	pump head (V.2)
------------	-----------------



reefdoser EVO 4

4-channel dosing pump incl. external controller

The Aqua Medic reefdoser EVO 4 can independently control the four dosing pumps included in the package. The dispensing of the food or additive can be achieved either manually or automatically; all pumps can be calibrated individually. The interval control allows for adjustment of the duration of the on/off cycle for each pump over a broad time span – from seconds to days. reefdoser EVO 4 can automate many tasks in an aquarium:

- regular dispensing of trace elements and fertilizers in salt- and fresh water aquarium
- controlled addition of calcium and bicarbonate into coral reef aquaria
- accurate dosing of Kalkwasser
- automatic feeding with live zoo plankton
- the external controller can be placed in a position away from the pumps to make it easy to use and allow for very simple programming

Incl. 4 m inlet hose (can be adjusted individually) to connect the dosing pumps to the containers with the dosing liquids.

Dimensions: app. 25 x 13 x 6.4 cm (l x w x h)

Item code	Item
104.144	reefdoser EVO 4

Options:

104.144-31	pump head (V.2)
------------	-----------------

6-tubes

Acrylic tube holder to attach up to six tubes (max. Ø 6 mm) on to the glass edge.

Item code	Item
410.37	6-tubes

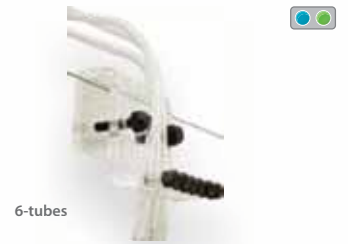

hose clip

Plastic clip

Flexible plastic clip designed for the safe fastening of hoses.

Item code	Item
410.38	hose clip Ø 5 – 6 mm
410.39	hose clip Ø 6 – 7 mm



SP 3000 Niveamat

Automatic top up unit with peristaltic pump and float switch

The SP 3000 Niveamat will automatically top up evaporated water in fresh and saltwater aquaria. It comprises a Niveamat SP 3000 peristaltic pump with a directly connected float switch. The float switch is installed in the aquarium or filter tank at the desired level using its holding unit. As the level drops the Niveamat SP 3000 automatically tops up the tank with water from a reservoir (not supplied).

Technical data Niveamat:

Capacity: 3 l/h pump, hose: Santoprene®, power consumption: 4.5 watts

Item code	Item
104.031	SP 3000 Niveamat SALE





power flotor S.3



power flotor M.3



power flotor L.3



incl. DC Runner 1.3 pump (skimmer version)



power flotor x.3

Compact and adjustable skimmer for sump use with App-control

We offer the power flotor skimmer in three different sizes: S.3 for aquaria up to 300 litres, M.3 for aquaria up to 400 litres, L.3 for aquaria up to 500 litres.

Equipment:

- control and programming via App (iTunes and Google Playstore) or manually via the controller
- 24 hour performance can be programmed
- integrated, adjustable 24 V pump DC Runner 1.3 incl. controller with button to allow skimmer to pause for feeding, 0 – 10 V connection enabled
- optimum bubble size and shape due to the effective Power Wheel
- near silent operation with the adjustable water outlet positioned on the bottom of the housing
- silencer that can be positioned freely
- foaming is adjustable both electronically and manually
- compact design allows for use in small areas
- can be completely dismantled for easy cleaning

power flotor	S.3	M.3	L.3
For aquaria	up to 300 l	up to 400 l	up to 500 l
Total consumption	max. 13 watts	max. 13 watts	max. 13 watts
Pump based skimmer	DC Runner 1.3	DC Runner 1.3	DC Runner 1.3
Air power	max. 350 l/h	max. 400 l/h	max. 450 l/h
Total height	app. 42 cm	app. 45 cm	app. 48 cm
Required space	app. 15 x 15 cm	app. 15 x 15 cm	app. 15 x 15 cm
Optimum water level in the filter sump	app. 14 – 18 cm	app. 14 – 18 cm	app. 16 – 20 cm

Item code	Item
411.310	power flotor S.3
411.320	power flotor M.3
411.330	power flotor L.3



Ocean Queen

Efficient and very powerful skimmer for sump use with App-control for “ultra silent” DC Runner pump

Features:

- extremely quiet and smooth operation thanks to the “ultra silent” pump with housing decoupling
- simple and convenient setting using App-control
- alternative setting option using the controller supplied with the feed stop button and 0 – 10 V connection
- power-saving 24 V pump
- high air entry, optimum bubble size and shape due to the new optimized Power Wheel
- innovative Foam Rails ensure precise bubble guidance in the skimmer housing
- directional foam formation by Bubble Booster in the base plate
- foam development can be controlled electronically and manually
- noise reduction due to adjustable water outlet on the bottom of the housing
- overpressure protection in the foam cup by Cup Control
- incl. effective silencer
- compact design allows for use in small areas
- can be completely dismantled for easy cleaning
- optimal filter sump adjustment by the variable pump position

Ocean Queen	90	160	300
For aquaria	up to 900 l	up to 1,600 l	up to 3,000 l
Total consumption	max. 18 watts	max. 31 watts	max. 58 watts
Pump based skimmer	DC Runner 2.3	DC Runner 3.3	DC Runner 5.3
Air power	max. 1,000 l/h	max. 1,800 l/h	max. 2,900 l/h
Total height	app. 480 mm	app. 540 mm	app. 590 mm
Height foam cup	app. 510 mm	app. 570 mm	app. 620 mm
Required space	app. 290 x 210 mm	app. 290 x 350 mm	app. 400 x 300 mm
Optimum water level in the filter sump	app. 15 – 19 cm	app. 19 – 23 cm	app. 19 – 23 cm

Item code	Item
412.310	Ocean Queen 90
412.320	Ocean Queen 160
412.330	Ocean Queen 300





K1



K1

Adjustable and very powerful skimmer with App-control for sump use

- extremely quiet and smooth operation thanks to the "ultra silent" pump with housing decoupling
- simple and convenient setting using App-control
- alternative setting option using the controller supplied with the feed stop button and 0 – 10 V connection
- power-saving 24 V pump
- high air entry, optimum bubble size and shape due to the new Power Wheel
- near silent operation with the adjustable water outlet positioned on the bottom of the housing
- silencer that can be positioned freely
- foaming is adjustable both electronically and manually
- compact design allows for use in small areas
- can be completely dismantled for easy cleaning

	K1
For aquaria	100 – 500 l
Total consumption	max. 18 watts
Pump based skimmer	DC Runner 2.3
Air power	max. 1,000 l/h
Total height	app. 45 cm
Height foam cup	app. 48 cm
Required space	app. 31 x 25 cm
Optimum water level in the filter sump	app. 14 – 18 cm

Item code	Item
412.210	K1 SALE

EVO 501

Motor driven adjustable internal skimmer

The power driven EVO 501 is especially characterized by the power-saving and efficient pump DC Runner 800 "ultra silent" (incl. DC motor) with power consumption of max. 7 watt. Polished ceramic bearings and shafts for brilliant silent performance and a maintenance-free steady use. Two holding systems for individual fixing, adjustable in height making it suitable for many different styles of aquarium. The 3D needle wheel will provide a large amount of air and optimum bubble structure. High skimming capacity is achieved by the special water flow and the conical foam cup. The included Silencer ensures an almost soundless operation.

EVO	EVO 501
For aquaria	up to 250 l
Pump	DC Runner 800
Power supply pump	24 V
Power supply transformer	110 – 240 V/50 – 60 Hz
Power consumption	max. 7 W
Total height	app. 365 mm
Dimensions (l x w x h)	app. 155 x 80 x 365 mm
Immersion depth	app. 23 cm

Item code	Item
410.018	EVO 501



EVO 1001

Motor driven adjustable external protein skimmer for saltwater aquaria up to 500 liters

The EVO 1001 is designed for installation in any mode: as a "hang on", it is simply hung over the edge of the aquarium. Only the venturi pump is inside the tank. The power-saving and efficient pump DC Runner 1000 "ultra silent" serves as a venturi pump (incl. DC motor, 24 V) with power consumption of max. 12 watt. Polished ceramic bearings and shafts for brilliant silent performance and a maintenance-free steady use. The 3D needle wheel will provide a large amount of air and optimum bubble structure. The included Silencer ensures an almost soundless operation. In the cabinet, it can be installed inside or outside the filter sump. It is designed to fit into nearly every standard aquarium cabinet.

EVO	EVO 1001
For aquaria	up to 500 l
Pump	DC Runner 1000
Power supply pump	24 V
Power supply transformer	110 – 240 V/50 – 60 Hz
Power consumption	max. 12 W
Total height	app. 455 mm
Dimensions (l x w x h)	app. 220 x 120 x 455
Immersion depth	app. 30 cm
Required space	app. 220 x 120 mm

Item code	Item
410.019	EVO 1001





Turboflotor 5000 Shorty II

Turboflotor 5000 Shorty II

Powerful skimmers for in cabinet installation

The water supply to the skimmer requires a second pump with a capacity of minimum 2,000 l/h (app. 500 gph). The skimmer may also be directly connected to the overflow of the aquarium.

Total height with foam cup Shorty II: app. 73 cm (footprint app. 30 x 50 cm)

Item code	Item
410.18	Turboflotor 5000 Shorty II for aquaria up to 1,500 l



Turboflotor 5000 baby ECO

Turboflotor 5000 single 6.0



Turboflotor 5000

Powerful skimmer with longer contact time for aquaria from 1,500 – 5,000 l (app. 375 – 1,250 gal)

The skimmer 5000 series were developed for larger aquaria. The reaction pipe has a diameter of 200 mm. A separate pump (2,000 – 3,500 l/h) is required for the water supply, e. g. DC Runner 5.3 or AC Runner 5.2. The venturi pumps of our DC Runner-series with brush wheel have a high skimming power, are very quiet in operation and have a low power consumption.

T 5000 baby ECO: Total height app. 107 cm, required space app. 50 x 29 cm (without outlet D40). Venturi pump - app. 50 watts

T 5000 single 6.0: Total height app. 185 cm, required space app. 50 x 29 cm (without outlet D40). Venturi pump - app. 50 watts

Item code	Item
400.017	Turboflotor 5000 baby ECO, 24 V, for aquaria up to 2,000 l, incl. DC Runner
400.023	Turboflotor 5000 single 6.0, 24 V, for aquaria up to 5,000 l, incl. DC Runner
400.018	Turboflotor 5000 baby ECO, 220 V / 50 Hz for aquaria up to 2,000 l, incl. AC Runner
400.024	Turboflotor 5000 single 6.0, 220 V / 50 Hz for aquaria up to 5,000 l, incl. AC Runner



Turboflotor 10000

Turboflotor 10000

It is made of an acrylic pipe and is designed for flow rates up to 10,000 l/h (app. 2,500 gph). It is recommended for larger aquaria up to 10,000 litres (app. 2,500 gallons) and professional aquaculture systems.

Technical data: Reaction chamber Ø: 50 cm (app. 20"), total height including foam cup: 184 cm (app. 72"), injector pump power consumption incl. motor protection switch: 550 watts, max. water flow: 10,000 l/h (app. 2,500 gph)

Item code	Item
400.05	Turboflotor 10000
400.15	Turboflotor 10000 w/o pump

Turboflotor 20000

Protein Skimmer for large aquaria

With the production of this skimmer Aqua Medic enters the area of water treatment for large professional aquaria. A powerful pump is combined with a venturi to provide an injection of app. 3,500 l/h. The maximum water flow rate is 20,000 litres (5,000 gallons) per hour. The Turboflotor 20000 is designed for larger tanks in public aquaria and for commercial use for pet fish importers and distributors. Technical data: Reaction chamber Ø: 50 cm (app. 20"), total height including foam collection cup: 286 cm (app. 113"), injector pump power consumption incl. motor protection switch: 750 watts, max. water flow: 20,000 l/h (app. 5,000 gph).

Item code	Item
400.00	Turboflotor 20000
400.10	Turboflotor 20000 w/o pump



Turboflotor 20000

miniflotor

Air driven internal skimmer for aquaria up to 200 litres (app. 50 gal)

The miniflotor is a small but powerful air-driven internal protein skimmer. A lime wood air diffuser producing very fine air bubbles is also included. The outer reaction tube is replaceable. A second shorter reaction tube is included in shipment. A membrane air pump with at least 300 l/h is necessary.

Ø app. 5 cm (app. 2"), length: with long tube app. 45 cm (app. 18") - with short tube app. 32 cm (app. 12.8"), total width: app. 15 cm (app. 6"), immersion depth: long tube app. 33 cm (app. 13.2"), short tube app. 20 cm (app. 8")

Item code	Item
410.50	miniflotor



miniflotor



We recommend: Mistral 400

midiflotor

Air driven internal skimmer for aquaria up to 400 litres (app. 100 gal)

The midiflotor is an air-driven counter current internal protein skimmer. The strong holding system allows movement of the skimmer vertically to adjust the foam production zone. A lime wood air diffuser, producing very fine air bubbles, is included. A membrane air pump with at least 300 l/h is necessary.

Ø app. 7.5 cm (app. 3"), length: app. 52 cm (app. 21"), total width: app. 15 cm (app. 6"), immersion depth: app. 30 – 35 cm (app. 12" – 14")

Item code	Item
410.55	midiflotor



midiflotor

We recommend: Mistral 400



Mini

Midi



Maxi

Wooden
airstones

Wooden airstones

For air driven protein skimmers

Wooden airstones are produced from lime wood with very fine pores. To keep the skimmer running at its optimum performance level, the bubbles have to be monitored regularly, and it is recommended that they are changed every 6 – 8 weeks. In an attractive blister pack.

Item code	Item
410.59	Wooden airstones Mini 2 pcs., app. 15 x 15 x 57 mm (l x w x h)
410.58	Wooden airstones Midi 2 pcs., app. 18 x 18 x 78 mm (l x w x h)
410.57	Wooden airstones Maxi 1 pc., app. 30 x 30 x 110 mm (l x w x h)



Silencer

Silencer

Silencer for protein skimmer

The Silencer 100 and the Silencer 200 reduce the noise of the air intake of a protein skimmer. The noise may be avoided by the use of the Silencers. At the fitting of the Silencer you can attach tubes with a diameter of 6/8 mm without any problems.

Item code	Item
410.610	Silencer 100 up to a capacity of 200 l air/h
410.620	Silencer 200 for a capacity higher than 200 l air/h

Filter Box A/B

Universal filter basin for salt- and freshwater aquaria

- glass filter basin in 2 sizes with 4 chambers
- holding plate including 2 pre-filter bags
- refill tank
- mechanical automatic refill
- adjustable water level in main filter chamber

Filter Box	A	B
Dimensions (l x w x h), app.	600 x 420 x 340 mm	900 x 420 x 340 mm
Refill tank	10 l	16 l

Item code	Item
510.175	Filter Box A
510.225	Filter Box B



Filter Box A

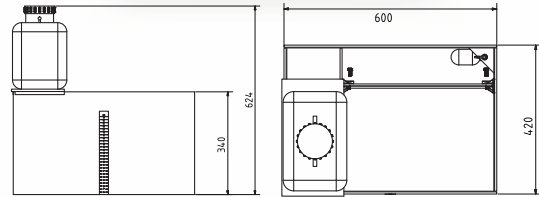

Filter Box B

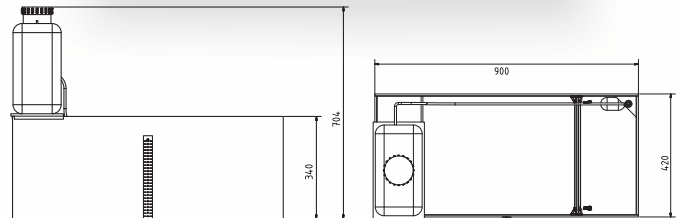

Cabinet Protect

Moisture protection for the base cabinet

Drip tray for drip water, suitable for Filter Box A / B

Cabinet Protect A: 700 x 440 x 30 mm
(Filter size max.: 650 x 420 mm)

Cabinet Protect B: 950 x 440 x 30 mm
(Filter size max.: 900 x 420 mm)



Cabinet Protect A

Cabinet Protect B

Item code	Item
502.110	Cabinet Protect A
502.130	Cabinet Protect B



Systemfilter 2000

Systemfilter 2000

A complete filter system for saltwater aquaria and holding tanks up to 5,000 litres (app. 1,319 gallons)

Systemfilter 2000 is a modular filter system delivered ready for use. It is designed for use as a centralized filter system for food fish holding tanks and for aquaria up to 5,000 l (app. 1,319 gallons).

The standard version comprises the following:

- protein skimmer Turboflotor 5000 single 6.0 incl. venturi pump, connection for external ozone supply
- prefilter chamber, post-switched biofilter, prepared to receive various filter materials
- UV-C clarifier, 1 x 80 watts, firmly integrated in the internal water cycle
- plastic vessel as filter sump, dimensions: app. 1,100 x 550 x 1,175 mm (l x w x h)
- internal circulation pump
- recirculating pump

All components are already piped.

Total required space: app. 1,400 x 800 x 1,900 mm (l x w x h)

optional:

- cooling unit on demand
- other pump combinations upon request
- the filter is also available without UV-C unit

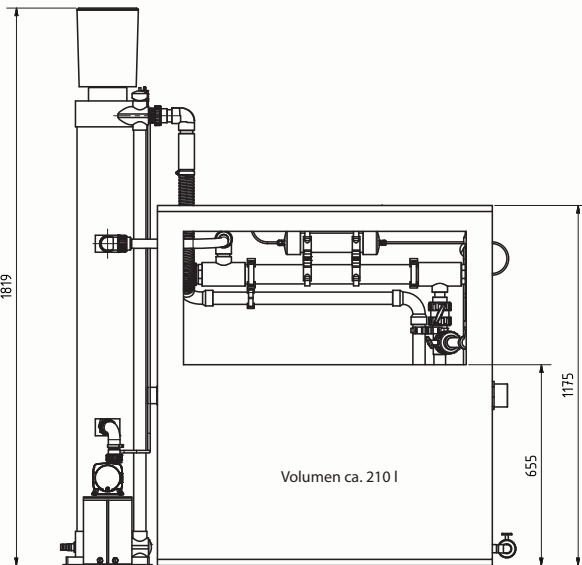

Item code	Item
405.80	Systemfilter 2000

Systemfilter Skim

A complete filter system for saltwater aquaria and holding tanks up to 20,000 litres (app. 5,277 gallons)

Systemfilter Skim is a modular filter system delivered ready for use. It is designed for use as a centralized filter system for food fish holding tanks and for aquaria up to 20,000 l (app. 5,277 gallons).

The standard version comprises the following:

- protein skimmer Turboflotor 15000 incl. venturi pump, connection for external ozone supply
- trickle filter for biological filtration (filled with BactoBalls)
- pressurized sand filter as final mechanic filter with back-flush valve
- plastic vessel as filter sump, dimensions: app. 1,290 x 940 x 1,300 m (l x w x h).
The tank is equipped with an underwater retaining system with 12 pcs. UV-C tubes with 20 watts each. With external switchboard for controlling.
- circulation pump capacity 12 m³/h (app. 3,000 gph)
- all components are already piped

Total required space: app. 260 x 95 x 255 cm (l x w x h)

optional:

- a second trickle filter and/or fine filter unit
- installation of a titanium heat exchanger for cooling or heating
- the filter is also available without UV-C unit

Equipment selectable upon agreement.

Item code	Item
406.50	Systemfilter Skim
406.51	Systemfilter Skim w/o UV



Systemfilter Skim

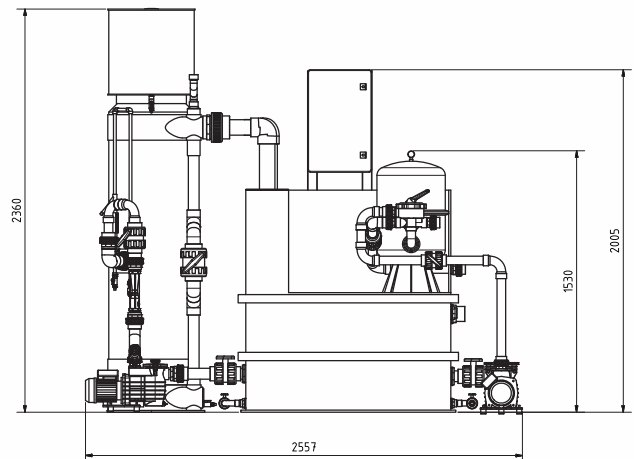



Systemfilter

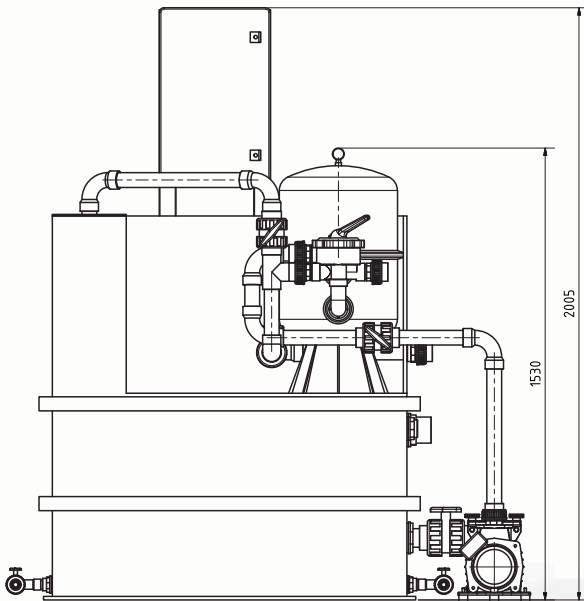

Systemfilter

A complete filter system for fresh- and saltwater aquaria and holding tanks up to 20,000 litres (app. 5,277 gallons)

Systemfilter is a modular filter system delivered ready for use. It is designed for use as a centralized filter system for food fish holding tanks and for aquaria up to 20,000 l (app. 5,277 gallons).

The standard version comprises the following:

- trickle filter for biological filtration (filled with BactoBalls)
- pressurized sand filter as final mechanic filter with back-flush valve
- plastic vessel as filter sump, dimensions: app. 1,290 x 940 x 1,300 mm (l x w x h). The tank is equipped with an underwater retaining system with 12 pcs. UV-C tubes with 20 watts each. With external switchboard for controlling.
- circulation pump capacity 12 m³/h (app. 3,000 gph)
- all components are already piped.

Total required space: app. 190 x 95 x 165 cm (l x w x h)

optional:

- a second trickle filter and/or fine filter unit
- installation of a titanium heat exchanger for cooling or heating.
- the filter is also available without UV-C unit

Equipment selectable upon agreement.

Item code	Item
405.50	Systemfilter
405.51	Systemfilter w/o UV

Refill System 2.0

Refill System with safety circuit

Easy and safe refilling of evaporated water in the aquarium

- permanent monitoring of the water level in the aquarium by means of a trouble-free and maintenance-free Reed sensor with delay circuit (no disturbance due to surface movement)
- automatic refilling of evaporated aquarium water
- variable sensor holder allows adaptation to different water levels in the filter tank
- dry-running protection of the refilling pump – optical and acoustic alarm
- there is a warning for low water level of the refill tank
- easy installation and maintenance, plug connections on all cables (incl. cable protection against unintentional release)
- safety shutdown circuit in case of a defective level sensor
- 12 V low voltage, incl. transformer 100 – 240 V / 50 – 60 Hz

Item code	Item
502.77	Refill System 2.0

**Refill System easy**

Refill system with pump and sensor

Easy and safe refilling of evaporated water in the aquarium

- permanent monitoring of the water level in the aquarium with an infrared sensor incl. delay circuit
- automatic refilling of evaporated aquarium water
- dry-running protection of the refilling pump
- easy installation and maintenance, plug connections on all cables
- sensor with magnet holder
- 12 V low voltage, incl. transformer 100 – 240 V / 50 – 60 Hz

Item code	Item
502.73	Refill System easy





refill depot
10 - 16 l



refill depot
20 - 30 l

refill depot

Canister for refill units

- large opening for easy filling
- canister with lid
- incl. tap
- versatile, made exclusively from PE
- odourless and tasteless
- food-safe
- can be emptied completely
- the inside can be cleaned by hand through the large opening

refill depot	10 l	16 l (1)	16 l (2)
Opening (mm) approx.	80	88	80
Thread	3/4"	3/4"	3/4"
incl. cap and tap	✓	-	✓
incl. cut-out and cap	-	✓	-
Weight (g) approx.	420	690	670
Dimensions mm (l x w x h) approx. (w/o tap)	280 x 170 x 285 mm	315 x 165 x 380 mm	310 x 170 x 360 mm

refill depot	20 l	25 l	30 l
Opening (mm) approx.	80	80	80
Thread	3/4"	3/4"	3/4"
incl. cap and tap	✓	✓	✓
incl. cut-out and cap	-	-	-
Weight (g) approx.	920	1,130	1,210
Dimensions mm (l x w x h) approx. (w/o tap)	285 x 250 x 390 mm	285 x 250 x 460 mm	285 x 250 x 550 mm

Item code	Item
510.075-1	refill depot 10 l for refill systems
502.79-1	refill depot 16 l (1) for refill systems
502.79-2	refill depot 16 l (2) for refill systems
502.79-3	refill depot 20 l for refill systems
502.79-4	refill depot 25 l for refill systems
502.79-5	refill depot 30 l for refill systems

multi reactor Gen II

All-In-One filter system

- for use in the aquarium or filter sump
- space-saving due to internal water supply
- highly efficient filtration due to high flow through your chosen filter media (sold separately) such as activated carbon (carbolit), phosphate absorber (antiphos FE), fine filter and so on
- adjustable water flow
- very simple maintenance due to removable filling tube, the filter housing incl. pump can remain in the aquarium for refilling and maintenance
- incl. pump of 12 V safety tension
- flexibly adjustable mounting system (multi reactor L can also be placed upright in the filter sump)
- extremely quiet in operation
- low vibration due to a decoupled pump connection
- optimized water flow with adjustable water level, low noise

Only valid for versions L + M:

- due to the new double-chamber-system two different types of filter media can be used simultaneously
- single-chamber-operation is also possible by removing the separating bottom of the reaction chamber

multi reactor Gen II	S	M	L
Dimensions (l x w x h), app.	60 x 50 x 325 mm	80 x 60 x 390 mm	100 x 100 x 465 mm
Gross volume	app. 270 ml	app. 540 ml	app. 1,200 ml
Filling quantity (without sponge)	app. 150 ml	app. 380 ml	app. 800 ml
Voltage	220 – 240 V/50 – 60 Hz		
Current consumption	12 V/app. 4 watts	12 V/app. 8 watts	12 V/app. 14 watts
Pump power	app. 200 l/h	app. 350 l/h	app. 450 l/h
For aquaria	up to 350 l	up to 500 l	up to 800 l
Max. glass thickness (for holder)	12 mm		

Item code	Item
409.930	multi reactor S Gen II
409.940	multi reactor M Gen II
409.950	multi reactor L Gen II

Fluidized bed filter FB 5000

Fluidized bed sand filter

The FB 5000 fluidized bed sand filter is a powerful but compact biological sand filter. The water enters the filter from the bottom and keeps the small quartz sand grains fluidized – a huge surface area is created and is optimally supplied with water and nutrients. FB 5000 can work as biological filter for aquarium systems up to 10,000 litres (app. 2,500 gallons).

Incl. 20 kg Quartz sand

Dimensions: Ø 20 cm (app. 8"), total height: 170 cm (app. 67")

Item code	Item
410.600	Fluidized bed filter FB 5000



multi reactor S Gen II



multi reactor M Gen II

multi reactor L Gen II



FB 5000



filter bag

filter bag

Zip up media bag

Filter bags are designed to contain fine filter media, such as activated carbon, antiphos Fe or other granular media. The filter bag is fitted with a zip fastener for quick and easy replacement of the media.

Item code	Item
429.01	filter bag 1, 2 pcs., 22 x 15 cm (app. 8.6" x 5.9")
429.02	filter bag 2, 2 pcs., 22 x 30 cm (app. 8.6" x 11.8")
429.03	filter bag 3, 2 pcs., 22 x 45 cm (app. 8.6" x 17.7")



filter bag 4



prefilter bag

prefilter bag

Filter bag (Ø app. 12 cm) with 200 µm for use as a prefilter in a cabinet filter. Incl. acrylic holder for max. 14 mm glass.

Item code	Item
429.10	prefilter bag
429.11	filter bag 4 (2 pcs.) - replacement Ø app. 90 mm, length app. 300 mm



filter bag multi

filter bag multi

Filter bag

Filter bag (Ø app. 10.5 cm) with 1,000 µm for use as a prefilter in a cabinet filter, without holder (e.g. Armatus)

Item code	Item
429.12	filter bag multi (2 pcs.) Ø app. 90 mm, length app. 230 mm

antiphos Fe

For the control of algal growth

Phosphate and silicate remover for freshwater and saltwater aquaria. antiphos Fe is an ideal medium for selectively extracting phosphate and silicate from aquarium water, thus counteracting unwanted algal growth. antiphos Fe is a highly active iron based product containing no aluminium and is completely non toxic to aquarium plants and animals. The binding capacity of antiphos Fe is app. 10 g phosphate/kg. Subject to the conditions 500 ml of antiphos Fe will treat a normally populated 300 l aquarium for app. 3 – 6 months.



antiphos Fe

Item code	Item
11651	antiphos Fe 500 g / app. 800 ml
12651	antiphos Fe 1,000 g / app. 1,600 ml

carbolit

For the removal of toxins and colours

Activated carbon pellets for fresh- and saltwater aquaria. carbolit comprises of highly efficient activated carbon pellets. carbolit quickly clears aquarium water and removes colouring substances, turbidity and medication residues. Yellowing substances such as phenols and tannins that can accumulate in the water are also removed. carbolit may also be used as a long-term filter material.



carbolit

Item code	Item
11518	carbolit 500 g/0.65 l, 1.5 mm Pellets
12518	carbolit 500 g/0.70 l, 4 mm Pellets
11519	carbolit 3.5 kg/4.55 l, 1.5 mm Pellets
12519	carbolit 3.5 kg/4.90 l, 4 mm Pellets
11516	carbolit 25 kg/32.5 l, 1.5 mm Pellets
12516	carbolit 25 kg/35.0 l, 4 mm Pellets

BactoBalls

Biological filter media

BactoBalls are the optimum filter medium for biological filters. They can be used in trickle filters and denitrification reactors and in larger aquaculture systems. The large surface area of 300 m²/m³ allows a high concentration of active bacterial biomass.



BactoBalls

Item code	Item
410.80	BactoBalls 25 l box (app. 6.25 gal) SALE
410.81	BactoBalls 5 l bucket (app. 1.3 gal) SALE
410.82	BactoBalls 15 l bucket (app. 3.75 gal) SALE

Larger quantities on request!



sulfur pearls

sulfur pearls

Filter medium for Sulphur denitrification reactors

sulfur pearls are sulphur beads formed from pure sulphur. They are used in sulphur nitratereductors as the filter medium and energy source for the bacteria. They have to be replaced from time to time as they are slowly consumed by the bacteria.

Caution:

Use only in nitrate removing anaerobic filters having a low water flow rate.

Item code	Item
410.79	sulfur pearls app. 1,000 g/app. 1,000 ml can
410.79-1	sulfur pearls app. 5,000 g/app. 5,000 ml bucket



Denigran



Denigran

Supports the natural decomposition of nitrate in salt- & freshwater aquaria, also helps clear algae problems

Denigran is a type of granular media made of special plastic material to enhance the settlement of nitrate removing bacteria. The main nutrient, nitrate is removed from the algae without any chemical additives; additional feeding of the bacteria is not required. The optimal designed mesh bag gives the best possible water flow past the media. Depending on the population, Denigran will be effective for up to 12 months.

Content: 4 mesh bags of 50 g each

Application: 1 – 2 bags per 50 liters of aquarium water

Item code	Item
411.76	Denigran 4 x 50 g



Deniballs

Deniballs

A filter material and bacteria feed for the Nitratereductor

Deniballs are manufactured from a unique biologically based plastic. 1 to 2.5 l Deniballs (app. 0.2 – 0,6 gal) is enough to supply the Nitratereductor as the sole food source for 12 months. For the Nitratereductor NR 5000, about 5 litres (1.3 gal) are required. Changing the Deniballs after approximately 12 months is recommended to ensure safe and maintenance free denitrification in fresh- and saltwater aquaria.

Item code	Item
410.78-1	Deniballs 5 l bucket SALE
410.78-3	Deniballs 25 l box SALE

Mini-Deniballs

A filter material and bacteria feed for the Nitratereductor

Mini-Deniballs are manufactured from a unique biologically based plastic. One package of 0.5 litres (app. 0.2 gal) is enough to supply a Nitratereductor as the sole food source for 12 months. Changing the Mini-Deniballs after approximately 12 months is recommended to ensure safe and maintenance free denitrification in fresh- and saltwater aquaria.



Mini-Deniballs

Item code	Item
411.78	Mini-Deniballs 0,5 l SALE

denimar

Nutrient powder for the Nitratereductor

The bacteria within an anaerobic biofilter need organic nutrients as their energy source to remove nitrate. If denimar is dosed daily, high nitrate removal rates can be achieved in the Nitratereductor. denimar is suited for salt- and freshwater aquaria. It contains no fertilizers and does not foster the growth of algae.



denimar

Item code	Item
410.76-1	denimar 150 g



Helix Max 2.0 11 W



Helix Max 2.0 series



according to EU regulation 2019/2015 and 2019/2020
Light source for germicidal applications with a peak radiation at 253.7 nm.
For disinfecting water, not suitable for other applications.

Helix Max 2.0

UV-C water clarifier for salt and fresh water aquaria

- can eliminate single cell algae giving crystal clear water in salt and fresh water aquaria
- helps eradicate bacteria and other water borne parasites and decreases the risk of fish acquiring infections
- controlled water flow and the large volume of the Helix Max 2.0 ensure maximum efficacy. The water is directed in a spiral path around the quartz tube resulting in more efficient use of the UV radiation than in standard units
- the inlet fitting can be rotated by 360° for easy mounting at any angle. This allows a space-saving installation
- easy cleaning of the inner spiral by simple disassembly
- simple and safe function control through integrated viewing window
- all versions of the Helix Max 2.0 are equipped with a high frequency electronic ballast for salt and fresh water aquaria. The electronic ballasts increase the lifetime and the efficacy of the UV lamps
- incl. hose nozzles for connecting hoses

Helix Max 2.0	5 W	9 W	11 W	18 W	36 W	55 W
Saltwater aquarium	up to 125 l	up to 250 l	up to 350 l	up to 500 l	up to 1,000 l	up to 1,500 l
Recommended max. flow	100–200 l/h	100–200 l/h	100–400 l/h	200–600 l/h	400–1,000 l/h	600–1,500 l/h
Freshwater aquarium	up to 250 l	up to 500 l	up to 750 l	up to 1,000 l	up to 2,000 l	up to 3,000 l
Recommended max. flow	100–300 l/h	100–500 l/h	300–800 l/h	400–1,000 l/h	500–1,500 l/h	700–2,500 l/h
Capacity	1.1 W/UVC	2.4 W/UVC	3.6 W/UVC	5.8 W/UVC	12 W/UVC	18 W/UVC
Cable length	3,5 m					
Lamp type	PL-S-5 W	PL-S-9 W	PL-S-11 W	PL-L-18 W	PL-L-36 W	PL-L-55 W
Max. pressure	0.4 bar					
Power connection	220–240 V 50/60 Hz					
Housing dimensions without joints l x w in mm, app.	370, Ø 90	370, Ø 90	370, Ø 90	380, Ø 110	540, Ø 110	695, Ø 110

Item code	Item
80705	Helix Max 2.0 5 W
80709	Helix Max 2.0 9 W
80711	Helix Max 2.0 11 W
80718	Helix Max 2.0 18 W
80736	Helix Max 2.0 36 W
80755	Helix Max 2.0 55 W



UVC-Max

Spare bulbs for Helix Max

Item code	Item
80805-8	UVC-Max 5 W
80809-8	UVC-Max 9 W
80811-8	UVC-Max 11 W
80818-8	UVC-Max 18 W
80836-8	UVC-Max 36 W
80855-8	UVC-Max 55 W

UV-C Professional

Modular UV-C system

Aqua Medic water clarifiers are suitable for fresh and saltwater aquaria. Helix Max can eliminate single cell algae giving crystal clear water in aquaria. The water is directed in a spiral path around the quartz tube resulting in more efficient use of the UV radiation than in standard units. This system consists of modules with 80 watts lamps. The housing consists of solid blue PVC tubes. The electronic ballast is placed in a switchbox together with an hour meter.



UV-C Professional

UV-C Professional	2 x 80 W	4 x 80 W	8 x 80 W	12 x 80 W
Saltwater aquarium	5 – 10 m ³	10 – 20 m ³	25 – 35 m ³	35 – 55 m ³
Recommended flow	10 m ³ /h	20 m ³ /h	30 m ³ /h	60 m ³ /h
Freshwater aquarium	10 – 20 m ³	20 – 40 m ³	50 – 70 m ³	70 – 110 m ³
Max. flow	15 m ³ /h	30 m ³ /h	50 m ³ /h	75 m ³ /h
Capacity	520 mW/cm ²	1,040 mW/cm ²	2,080 mW/cm ²	3,120 mW/cm ²
Lamp type	80 W T5			
Power connection	230 V~/50 Hz			
Dimensions l x w in mm, app.	920 x 365	1,055 x 545	982 x 787	1,055 x 585
Connection	Ø 63 mm	Ø 63 mm	Ø 75 mm	Ø 75 mm

Item code	Item
81828	UV-C Professional 2 x 80 W
81848	UV-C Professional 4 x 80 W
81888	UV-C Professional 8 x 80 W
81898	UV-C Professional 12 x 80 W



 **according to EU regulation 2019/2015 and 2019/2020**
 Light source for germicidal applications with a peak radiation at 253.7 nm.
 For disinfecting water, not suitable for other applications.

Spare bulb for UV-C Professional 80 W

Item code	Item
80891-8	Spare bulb for UV-C Professional 80 W



Spare bulb for UV-C Professional 80 W



optional: spectrus holder BW
(see page 65)



according to EU regulation 2019/2015 and 2019/2020
Aquarium light with more than 40% of the total radiation in the range 400 – 480 nm for the coral-zooxanthellae symbiosis and plant growth, not suitable for other applications.

spectrus / spectrus twin

Innovative LED aquarium light for saltwater aquaria with App-control

The spectrus with its elegant, slim aluminium housing offers illumination of the aquarium whilst incorporating the latest technology. Active cooling with powerful, quiet internal fans ensures maximum power output at a constant operating temperature. The compilation of the six individual light colours is specifically adjusted to the needs of animals in saltwater aquaria with a balanced light spectrum. By using an efficient lens technology, the light energy is optimally used. The growth of corals is supported and the biology in the aquarium develops in a natural way. The 8 light colours can be controlled individually with 6 colour channels via an App control in the light for different intensity and colour spectrums. Thanks to the WiFi control, several lights can be integrated into the home network and can act as master and slave with each other. This means that time-controlled programs can be implemented for any time of day.

Equipment:

- LED light with 8 colours and 6 channels
- App-control (IOS and Android)
- several LED lights can be controlled at the same time
- anodized aluminium housing for cooling actively
- for safety 24 V with external transformer (100 – 240 V / 50 – 60 Hz)
- incl. steel wire suspension
- high-quality power pack

optional:

- spectrus holder BW

spectrus	spectrus	spectrus twin
Total consumption max./W	95	190
Power supply transformer	100 – 240 V / 50 – 60 Hz	
Power supply light	24 V DC	
Number of light channels	6	6
Number of light colours	8	8
Total lumen app.	3,044	6,158
PAR max.	2,400	2 x 2,400
Illuminated area max./mm	600 x 650	1,000 x 650
For aquarium with length app./mm	up to 650	up to 1,000
Weight (lamp without holder) app./g	790	2,280
Dimensions (l x w x h) app./mm	140 x 140 x 31	420 x 140 x 31
Light colours – Colour temperature	cool white 8,300 K royal blue 450 nm deep blue 460 nm cool blue 470 nm	red 660 nm violet 415 nm UV 405 nm UV 395 nm

Item code	Item
83020010	spectrus
83020020	spectrus twin
Options:	
83020100	spectrus holder BW

aquarius plus

LED aquarium light for saltwater aquaria with app control

The aquarius plus with its flat aluminium housing offers particularly even illumination of your aquarium. The combination of the six individual light colours is specially tailored to the needs of saltwater aquaria. The 6 colour channels can be individually set in the light intensity for different color gradients using an app control. This means that time-controlled programs can be implemented for any time of day.

Equipment:

- LED light with 6 colours and 6 channels
- App control (IOS and Android)
- anodized aluminium housing for passive cooling (no fans)
- Safety voltage 24 V with external transformer (100 – 240 V / 50 – 60 Hz)
- variable bracket for mounting on the aquarium

optional:

- aquafit 2 steel wire suspension
- aquarius plus holder BW

aquarius plus	30	60	90	120
Total consumption max./W	38	77	118	155
Total Lumen app./lm	2,510	4,900	7,678	9,945
Dimensions (l x w x h) app./mm	320 x 210 x 25	580 x 210 x 25	840 x 210 x 25	1,100 x 210 x 25
Total cable length app.	3.50 m incl. power adapter			
For aquarium with length app./mm	350 – 600	600 – 900	850 – 1,100	1,150 – 1,350
Light colours – Colour temperature	white 6,000 – 6,500 K	royal blue 450 – 455 nm	red 620 – 625 nm	purple 395 – 405 nm
	blue 460 – 465 nm	UV 365 – 370 nm		

Item code	Item
89711	aquarius 30 plus
89712	aquarius 60 plus
89713	aquarius 90 plus
89714	aquarius 120 plus

Options:

89706	aquarius plus holder BW
-------	-------------------------



aquarius 120 plus 155 W
aquarius 90 plus 118 W
aquarius 60 plus 77 W
aquarius 30 plus 38 W

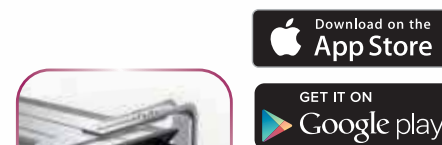

optional:
aquarius plus holder BW
(see page 65)

 according to EU regulation 2019/2015 and 2019/2020
Aquarium light with more than 40% of the total radiation in the range 400 – 480 nm for the coral-zooxanthellae symbiosis and plant growth, not suitable for other applications.



aquarius plant plus



aquarius plant 120 plus
128 W

aquarius plant 90 plus
95 W

aquarius plant 60 plus
65 W



aquarius plant 60 plus



optional:
aquarius plus holder BW
(see page 65)

aquarius plant plus

LED aquarium light for freshwater aquaria with app control

The aquarius plant plus with its flat aluminium housing offers a particularly even illumination of your aquarium. The combination of the six individual light colours is specially tailored to the needs of freshwater aquaria. The 6 colour channels can be individually set in the light intensity for different color gradients using an app control. This means that time-controlled programs can be implemented for any time of day.

Equipment:

- LED light with 6 colours and 6 channels
- App control (IOS and Android)
- anodized aluminium housing for passive cooling (no fans)
- Safety voltage 24 V with external transformer (100 – 240 V / 50 – 60 Hz)
- variable bracket for mounting on the aquarium

optional:

- aquafit 2 steel wire suspension
- aquarius plus holder BW

aquarius plant plus	60	90	120
Total consumption max./W	65	95	128
Total Lumen app./lm	4,550	6,825	9,110
Dimensions (l x w x h) app./mm	580 x 210 x 25	840 x 210 x 25	1,100 x 210 x 25
Total cable length app.	3.50 m incl. power adapter		
For aquarium with length app./mm	600 – 900	850 – 1,100	1,150 – 1,350
Light colours – Colour temperature	daylight white 6,000 – 6,500 K warm white 2,800 – 3,200 K red 640 – 660 nm	ruby red 620 – 630 nm green 520 – 530 nm blue 460 – 470 nm	

Item code	Item
89812	aquarius plant 60 plus
89813	aquarius plant 90 plus
89814	aquarius plant 120 plus
Options:	
89706	aquarius plus holder BW

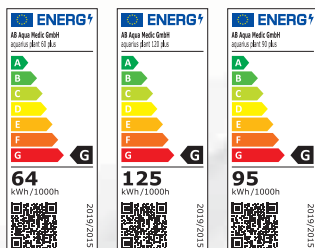

aquarius plus holder BW

Rear wall bracket, only for aquarius plus LED lights

aquarius plus	30	60	90	120
Recommended number of holders	1	2	2	2

Item code	Item
89706	aquarius plus holder BW



aquarius plus holder BW

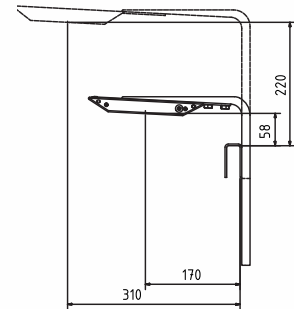

spectrus holder BW

Rear wall bracket, only for spectrus lights

spectrus	spectrus	spectrus twin
Recommended number of holders	1	1

Item code	Item
83020100	spectrus holder BW



spectrus holder BW

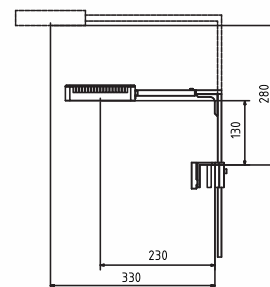



Qube 40

Qube 40

LED-Spot light for saltwater aquaria

Features:

- LED chip consisting of 25 individual LED elements with balanced light spectrum
- individual lenses ensure optimum light pattern
- high energy density specially designed for strong coral growth (PAR= 1,150 $\mu\text{mol m}^{-2}\text{s}^{-1}$)
- amount of light dimmable via touch key
- integrated timer - 8, 10 and 24 hours
- the compact design allows for an ideal illumination of nano aquaria as well as dark edge areas in larger aquaria.
- silent-running internal fan for reliable cooling of the LED's
- a flexible gooseneck ensures a firm hold and easy alignment
- integrated cable feedthrough for power supply in the gooseneck

LED	cool white	9.000 K	4 pcs.
	sky blue	470 nm	6 pcs.
	deep blue	460 nm	5 pcs.
	royal blue	450 nm	8 pcs.
	violet	420 nm	2 pcs.

Technical data:

Dimensions (housing)	app. 80 x 80 x 25 mm
Weight incl. holder	app. 365 g
Number of light channels	1
Number of light colours	5
Illuminated area max.	app. 300 x 300 mm
PAR value	1,150 $\mu\text{mol m}^{-2}\text{s}^{-1}$
Total consumption	40 watts max.
Power supply transformer	100 – 240 V / 50 – 60 Hz
Power supply light	24 V
Protection class	IP X4



Item code	Item
83216040	Qube 40



according to EU regulation 2019/2015 and 2019/2020

Aquarium light with more than 40% of the total radiation in the range 400 – 480 nm for the coral-zooxanthellae symbiosis and plant growth, not suitable for other applications.

Qube 60

High Power LED-Spot with App-control for saltwater aquaria

Features:

- LED chip consisting of 25 individual LED elements with balanced light spectrum
- individual lenses ensure optimum light pattern
- high energy density specially designed for strong coral growth (PAR = 2,350 $\mu\text{mol m}^{-2}\text{s}^{-1}$)
- App control (IOS and Android)
- several LED lights can be controlled
- the compact design allows for an ideal illumination of nano aquaria as well as dark edge areas in larger aquaria
- silent-running internal fan for reliable cooling of the LED's
- a flexible goose neck ensures a firm hold and easy alignment

LED	cool white	9.000 K	6 pcs.
	red	660 nm	1 pc.
	sky blue	470 nm	2 pcs.
	deep blue	460 nm	7 pcs.
	royal blue	450 nm	7 pcs.
	violet	420 nm	1 pc.
	UV	410 nm	1 pc.

Technical data:

Dimensions (housing)	app. 90 x 90 x 80 mm
Weight incl. holder	app. 870 g
Number of light channels	6
Number of light colours	7
Illuminated area max.	app. 500 x 500 mm
PAR value	2,350 $\mu\text{mol m}^{-2}\text{s}^{-1}$
Total consumption	60 watts max.
Power supply transformer	100 – 240 V / 50 – 60 Hz
Power supply light	24 V
Protection class	IP X4

Item code	Item
83216060	Qube 60



according to EU regulation 2019/2015 and 2019/2020
 Aquarium light with more than 40% of the total radiation in the range 400 – 480 nm for the coral-zooxanthellae symbiosis and plant growth, not suitable for other applications.



Qube 30 plant

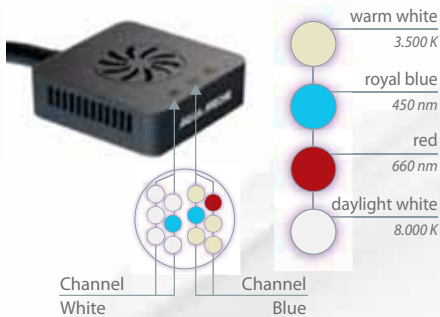
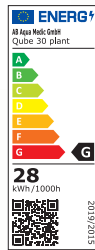

Qube 30 plant

LED-Spot light for freshwater aquaria

Features:

- LED Cluster chip consisting of 12 individual LED elements with balanced light spectrum
- high energy density specially designed for strong plant growth (PAR = 805 $\mu\text{mol m}^{-2}\text{s}^{-1}$)
- colour and light intensity are adjustable manually via 2 channels
- the compact design allows for an ideal illumination of nano aquaria as well as dark edge areas in larger aquaria.
- silent-running internal fan for reliable cooling of the LED chip
- a flexible gooseneck ensures a firm hold and easy alignment
- integrated cable feedthrough for power supply in the gooseneck

LED	daylight white	8,000 K	5 pcs.
	warm white	3,500 K	4 pcs.
	royal blue	450 nm	2 pcs.
	red	660 nm	1 pc.

There is a lense with 90° scattering angle installed.

Technical data:

Dimensions (housing)	app. 80 x 80 x 25 mm
Weight incl. holder	app. 290 g
Number of light channels	2
Number of light colours	4
Illuminated area max.	app. 300 x 300 mm
PAR value	805 $\mu\text{mol m}^{-2}\text{s}^{-1}$
Total consumption	30 watts max.
Power supply transformer	100 – 240 V / 50 – 60 Hz
Power supply light	24 V

Item code	Item
83217030	Qube 30 plant

Qube 50 plant

High Power LED-Spot light for freshwater aquaria

- LED Cluster chip consisting of 24 individual LED elements with balanced light spectrum
- high energy density specially designed for strong growth (PAR = 1.410 $\mu\text{mol m}^{-2}\text{s}^{-1}$)
- colour and light intensity are adjustable manually via 2 channels
- integrated 0 – 10 V connection for using external controllers
- the compact design allows for an ideal illumination of nano aquaria as well as dark edge areas in larger aquaria
- silent-running internal fan for reliable cooling of high-power LED-chips
- a flexible goose neck ensures a firm hold and easy alignment, a wire suspension system for mounting on the ceiling is included

LED	daylight white	8,000 K	10 pcs.
	warm white	3,000 K	4 pcs.
	red	660 nm	2 pcs.
	green	520 nm	1 pc.
	royal blue	450 nm	6 pcs.
	blue	420 nm	1 pc.

There is a lense with 90° scattering angle installed.

Technical data:

Dimensions (housing)	app. 80 x 80 x 65 mm
Weight incl. holder	app. 725 g
Number of light channels	2
Number of light colours	6
Illuminated area max.	app. 500 x 500 mm
PAR value	1,410 $\mu\text{mol m}^{-2}\text{s}^{-1}$
Total lumen	app. 1364 lm
Total consumption	50 watts max.
Power supply transformer	100 – 240 V/50 – 60 Hz
Power supply light	24 V

Item code	Item
83217050	Qube 50 plant



Qube 50 plant

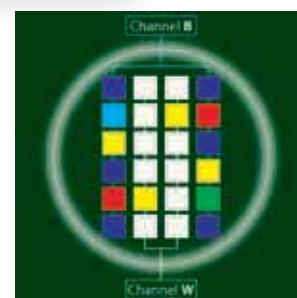

optional: Qube control



Qube control

Qube control

2-channel light control for Qube 50 plant

- two independently programmable / dimmable channels for blue phase, sunrise, sunset and moonlight
- by using a connecting cable (included in shipment) several Qubes can be connected in series to be controlled simultaneously
- programming is completed via the supplied remote control from the Qube control by timer. No connection to the PC is therefore necessary.
- power (24 V low voltage) is supplied via the Qube lights power pack, no additional power supply is required
- can be used with all 0 – 10 volt control lamps (if necessary, separate power supply required)

Dimensions (l x w x h): app. 74 x 74 x 15 mm

Cable length: app. 1,400 mm

Item code	Item
83216000	Qube control

LED FA 100/200 W flex

Splash-proof LED spotlight (IP65)

The LED spotlight housing is a highly efficient, low-profile cooling element designed for passive cooling. The LED lights FA 100 flex and FA 200 flex are equipped with individual LEDs in white and blue. Both colours can be dimmed separately. For optimum light spread, a special lens plate with individual lenses for each LED is installed. The Meanwell ballast guarantees for a reliable and safe power supply. The light consists of individual LEDs with a respective viewing angle of 60° per LED. By an optional manual dimming both light channels can be adjusted optimal to the individual needs. A holder for the ceiling is included.

Technical data:

LED FA	100 W flex	200 W flex
Dimensions (l x w x h) (without clamp)	290 x 180 x 130 mm	360 x 290 x 160 mm
Weight app.	4.2 kg	7.1 kg
Total luminous flux app.	6,700 Lm	13,500 Lm
Light colour	white: 8,100 K, blue: 455 nm	
Total viewing angle app.	60°	
Viewing angle per LED app.	60°	
Power supply	100 – 240 V / 50 – 60 Hz	
Total LEDs	96 pcs.	192 pcs.
LEDs per colour	48 x white, 48 x blue	96 x white, 96 x blue



LED FA 100 W flex



LED FA 200 W flex

according to EU regulation 2019/2015 and 2019/2020
 Aquarium light with more than 40% of the total radiation in the range 400 – 480 nm for the coral-zooxanthellae symbiosis and plant growth, not suitable for other applications.

Item code	Item
83618150	LED FA 100 W flex
83618250	LED FA 200 W flex

Options:

83414210	Potentiometer LED
----------	-------------------

spot control

Light control for up to three LEDspot flex or LED FA flex

- three control outputs for one spot each with two channels
- all settings are made directly on the spot control using a real-time clock, no connection to the PC necessary
- the power supply (24 V safety voltage) is ensured via its own power supply

Item code	Item
83416004	spot control

Options:

83400004	Control cable/2020 LEDspot und LEDspot flex
83416003	Y-Control cable LEDspot/LEDspot flex



spot control



Suspension	Aqua Medic light system
aquafit	aquaspacelight 400 aquasunlight NG aquastarlight T5 Ocean Light T5 sunbeam
aquafit 2	aquareefLED aquasunLED Ocean Light T5 aquarius aquarius plant aquarius plus aquarius plant plus
aquafit 3	Ocean Light LED Ocean Light LED twin ECOplant LED ECOplant LED twin



aquafit

aquafit

Steel Wire Suspension

The wire suspension system aquafit provides a neat and simple method of ceiling mounting of Aqua Medic and other suitable lights. The suspension system contains 2 pcs. of the following: ceiling plate with retaining bush, stainless steel, top screw fitting, wire with ferrule, light fixing incl. top cap, plastic washer, screws and wall fixings and clips to secure the wire's end.

Item code	Item
80400	aquafit



aquafit 2

aquafit 2

Steel Wire Suspension

Universal suspension kit for use with all suspended lighting units, provided that the screws in the housing's end plates are of adequate length & not too wide (max. Ø 4 mm). aquafit 2 consists of 2 pieces of: 2 metre stainless steel wire with stopper, ceiling plate with retaining bush, steel wire with height and angle adjustment unit attached, screws and plugs. The suspension kit allows fixing of the lighting unit to the ceiling and provides easy adjustment in both height and angle of unit.

Item code	Item
80401	aquafit 2



aquafit 3

aquafit 3

Steel Wire Suspension

Suitable for Aqua Medic Ocean Light LED-, ECOplant-series, may also be suitable for other lights that have Ø M3 thread fixings to attach the cable holder onto the top of the light housing. aquafit 3 consists of 2 pieces of 2 metre stainless steel wire with stopper, ceiling plate with retaining bush, steel wire with height and angle adjustment unit attached, screws and plugs. The suspension kit allows fixing of the light unit to a suitable ceiling and provides easy adjustment in both height and angle of the unit.

Item code	Item
80402	aquafit 3

T controller twin

Digital temperature monitor and controller, for the control and monitoring of heating systems and cooling units simultaneously

The temperature controller T controller twin is used for controlling both heating systems and cooling units. Measuring and switching accuracy is 0.1°C. The control range varies from 16 – 40°C, and the set value is in 0.1 °C increments. **The maximum load for heating systems is 1,200 watts and 460 watts for cooling units.** Because of the integrated double socket it is possible to connect a heating system and cooling unit simultaneously. The T controller twin is supplied with a waterproof temperature probe. The LCD display provides instant information on the current temperature. The minimum and maximum values can be easily adjusted.

(IP65)

Item code	Item
200.25	T controller twin



T controller

Temperature monitor and controller

The T controller is available in 2 versions: T controller HC for the control of heating systems and T controller CC for the control of cooling units. The control range varies from 0 to 50 °C, with an accuracy of ±0.1 °C. The maximum load is 1,000 watts for heaters and 600 watts for coolers. The units are supplied with a waterproof temperature probe.

Item code	Item
200.15	T controller CC with probe
200.20	T controller HC with probe



cool control

Digital temperature monitor and controller, for the control and monitoring of fans

The temperature controller cool control with touch screen display is used for controlling 12 or 24 volt fans with coaxial connectors (5.5 mm x 2.1 mm). The switching accuracy is 0.5 °C. The control range varies from 0 – 36 °C, and the set value is in 0.1 °C increments. The cool control is supplied with a waterproof temperature probe. The LCD display provides instant information on the current temperature. The set value and fan power (40 – 99%) are also displayed and can be easily adjusted.

- high and reliable switching accuracy
- maximum switching power: 65 W
- dimensions: l x w x h app. 120 x 62 x 28 mm
- cable length power supply to the fan: 150 cm
- cable length temperature sensor: 100 cm

Item code	Item
200.26	cool control





heat controller duo II



heat controller duo II

Digital temperature monitor and controller, for controlling and monitoring of under gravel heater and other heating systems

The temperature controller heat controller duo II is used for controlling heaters and under gravel heating systems at the same time. Measuring and switching accuracy is 0.1 °C. The control range varies from 0 – 50 °C, the set value is in 0.1 °C increments and is controlled exactly to 1 °C. The maximum load for the heating systems and under gravel heater is 1,200 watts. Because of the integrated double socket it is possible to connect a heater and an under gravel heating system simultaneously.

The heat controller duo II is supplied with a temperature probe attached. The LCD display provides instant information on the current temperature, time and state of the connected units. The heating cable is controlled by a timer, the on/off time can be programmed. If the set value is not reached, the under gravel heater is switched on. To avoid overheating, both sockets switch off as soon as the set value is reached.

Item code	Item
200.32	heat controller duo II



Titanium Heater

Titanium Heater

Titan Aquarium Heater

Titanium heaters are the safe alternative to glass heaters in both fresh- and saltwater aquaria. The unbreakable titanium housing is saltwater resistant and the heaters have both overheat and dry running protection cutouts. The heaters must be used in combination with a temperature controller. For temperature-dependent control we recommend optional the use of our T controller twin. Ø 20 mm

Item code	Item
110.010	Titanium heater 100 W, for aquaria up 100 – 250 l, length: app. 27 cm (app. 10.6")
110.020	Titanium heater 200 W, for aquaria up 250 – 500 l, length: app. 28 cm (app. 11")
110.030	Titanium heater 300 W, for aquaria up 500 – 1,000 l, length: app. 30 cm (app. 11.8")
110.050	Titanium heater 500 W, for aquaria up 1,000 – 1,500 l, length: app. 32 cm (app. 12.6")



pH controller

pH controller

pH monitor and controller

The pH controller is a precision instrument for controlling the pH value in aquaria. In combination with a CO₂ system and a solenoid valve the pH can be maintained at a constant level, and the CO₂ supply to aquatic plants or into a Calcium reactor can be controlled. The unit is supplied with a large LED display and the control range is digitally adjustable from pH 3.5 to 10.5. **The direction of adjustment can be set up or down.** The pH controller has a BNC connection for pH electrodes. The use of an original Aqua Medic plastic shafted electrode is recommended.

Item code	Item
200.00	pH controller w/o probe

pH monitor

pH meter for exact measuring of the pH value

The pH monitor is a precision instrument for controlling permanently the pH value in aquaria. The LED display continuously shows the current pH value of the aquarium water. The measuring range covers pH-values from 0.00 to 14.00. The test liquids included in delivery allow an exact calibration of the electrode that is connected to the pH monitor via a BNC connection.

Included:

pH monitor, pH electrode with BNC fitting, elektrode holder, test liquids for calibration

The warranty for probes/electrodes is 6 months.

Item code	Item
203.00	pH monitor
Options:	
204.000	Universal holder NEW



pH computer-Set

Microprocessor controlled pH monitor and controller

The pH computer-Set utilises a modern microprocessor, which provides high precision measurement and control. The pH computer-Set is used to control precise values of pH in the aquarium or the calciumreactor. The direction of control can be set upwards or downwards. The computer can switch up to 500 watts using the supplied external electrical socket. When the calibration key has been selected the unit will automatically calibrate itself to the electrode. A plastic shafted pH electrode with BNC fitting and the correct calibration fluids are included.

The warranty for probes/electrodes is 6 months.

Item code	Item
201.00	pH computer-Set



pH-control-Set

Includes: controller, pH-sensor, sensor holder, pH-test fluid and M-ventil Eco

The warranty for probes/electrodes is 6 months.

Item code	Item
200.50	pH-control-Set





mV controller

mV controller

Redox-potential (ORP) monitor and controller

The mV controller is designed for monitoring and controlling the redox potential (or ORP - oxidation-reduction potential) in aquaria. The unit has a broad controlling range from -500 to a +500 mV, and a measuring range from -1,000 to +1,000 mV. It can be used to control the supply of ozone in saltwater aquaria and/or for the control of nitrate removal in anaerobic biological filters (Nitratereducator). The unit is supplied with a BNC connection for a mV probe. The use of an original Aqua Medic plastic shafted electrode is recommended.

Item code	Item
200.05	mV controller without probe



mV monitor

mV monitor

mV meter for exact measuring of the redox potential

The mV monitor is a precision instrument for controlling permanently the redox potential in aquaria. The LED display continuously shows the current redox value of the aquarium water. The measuring range covers mV-values from -1,999 to +1,999. A 230 mV test solution, available as an accessory, allows checking and adjusting the electrode that is connected to the mV monitor via a BNC connection.

Included:

mV monitor, mV electrode with BNC fitting, electrode holder, 0-point-plug, power supply



Item code	Item
203.05	mV monitor

Options:

204.000	Universal holder NEW
---------	-----------------------------



mV computer-Set

mV computer-Set

Microprocessor controlled redox-potential (ORP) monitor and controller

The mV computer-Set uses the same microprocessor technique as the pH computer-Set. Waterproof touch keys are used to set the required values and calibrate the electrode. The mV computer-Set is ideal for controlling anaerobic biological filters such as the Nitratereducator which have negative redox potential or can control the supply of ozone to the aquarium, or monitor the aquarium water's redox potential. All these functions are possible due to the computer's broad measurement and control range of -500 to +1,000 mV. The direction of control can be set upwards or downwards. The status of the direction of control and the output are shown on LED's. A plastic shafted mV electrode with a BNC fitting and calibration fluid is included.

The warranty for probes/electrodes is 6 months.

Item code	Item
201.05	mV computer-Set

LF controller

Conductivity monitor and controller

The salt content of water can be determined by measuring the electrical conductivity. A special feature of the LF controller conductivity monitor and controller is the broad measurement and control range which is divided into 2 bands: from 0 to 2,000 μ S, the unit is used for monitoring desalinated water and freshwater, and in the range 0 to 200 mS, it is used for brackish and saltwater. The unit can therefore be used for the control of reverse osmosis units, for monitoring breeding tanks with soft water, and for the control of the salt content in saltwater aquaria. The unit is supplied with a directly connected, saltwater resistant graphite electrode.

The warranty for probes/electrodes is 6 months.



Item code	Item
200.10	LF controller with probe

T-meter

Submersible digital thermometer incl. rubber sucker and battery.

Item code	Item
203.20	T-meter



T-meter II

External aquarium thermometer for fixing on the aquarium glass (outside) or in the cabinet

- compact design and easy operation
- large LCD display showing the water temperature
- separate power button for turning off the display (power saving mode)
- external temperature sensor, can be hidden in the aquarium
- selectable temperature unit: °C or °F
- easy fixing on the aquarium glass by suction cups
- can also be fixed to the cabinet

Measuring range: +5~+45 °C (+41~+113 °F)

Measuring steps: 0.1 °C / 0.1 °F

Measuring accuracy: ± 1 °C (2 °F)

Power supply: 1.5 V (AG13/LR44)

Attention: Do not immerse the display unit in water. Only the sensor is water-proof.

Display = "H °C" – the temperature is above the measuring range

Display = "L °C" – the temperature is below the measuring range

Item code	Item
203.22	T-meter II





T-meter twin

T-meter twin

External double-display thermometer

Large double LCD display simultaneously showing aquarium and ambient temperature. Selectable temperature unit: °C or °F. With adhesive tape at back side for easy putting on aquarium tank.

Ambient: -10 ~ +50 °C (-14 ~ +122 °F)

Aquarium: -50 ~ +70 °C (-58 ~ +158 °F)

Resolution: 0.1 °C / 0.1 °F

Accuracy: ±1 °C (2 °F)

Power supply: 1.5 V (AG10)

Item code	Item
203.10	T-meter twin

ozone 30/90/250/400

Ozone generator

The ozone generators of the ozone series are based on the latest low-voltage technology. They reliably prevent the water from turning yellow and the water becomes crystal clear. Ozone improves protein skimming and increases the redox potential. The bacterial load in the water is reduced, thus preventing fish diseases. In addition, the degradation of toxic nitrite is supported. The units of the ozone series are adjustable and available in the power levels from 30 – 400 mg/h.

- suitable for freshwater and saltwater aquaria



ozone	30	90	250	400
Ozone power mg/h	max. 30	max. 90	max. 250	max. 400
Power consumption (w) app.	2.5	3.5	5	5
Power supply ozone generator	12 V			
Power supply transformer	110 – 240 V / 50 – 60 Hz			
Air flow (l/h) ca.	30 – 500	50 – 500	100 – 500	200 – 500
For freshwater aquaria up to water volume (l)	800	1,500	3,000	4,000
For saltwater aquaria up to water volume (l) (l)	500	800	1,500	2,500
Connection for hose (mm)	4/6			
Dimensions l x w x h (mm) app.	178 x 84 x 46			

Item code	Item
204.030	ozone 30
204.090	ozone 90
204.250	ozone 250
204.400	ozone 400

Options:

204.000	Universal holder NEW
---------	-----------------------------



Ozoniser S 500

Ozoniser XT 2000

Ozonizer

Ozonizer

The wear-resistant components offer high-power ozone production with optimum power consumption. The ceramic electrode can be easily cleaned, if necessary. The ozone quantity can be adjusted continuously via a potentiometer. The XT 2000 is equipped with a large touch display that allows convenient operation and precise adjustment of all operating parameters.

Ozonizer	Ozonizer S 500	Ozonizer S 1000	Ozonizer XT 2000
Ozone output - mg/h	0 – 500	0 – 1,000	0 – 2,000
Continuous adjustment - %	0 – 100	0 – 100	0 – 100
Power consumption - watts	12	24	42
Air flow - l/h	200 – 1,000	200 – 1,000	50 – 1,000
Freshwater quantity up to - l	10,000	20,000	40,000
Saltwater quantity up to - l	5,000	10,000	20,000

Item code	Item
202.905	Ozoniser S 500 - Sander
202.910	Ozoniser S 1000 - Sander
202.920	Ozoniser XT 2000 - Sander



Ozone Booster

Ozone Booster

Air dryer

The air dryer is for use with any Aqua Medic Ozone Generators. Ozone output can decrease dramatically if the supply air is very humid. Ozone Booster should be used to dry the air, particularly if a protein skimmer is supplied with ozone using the humid air present in the aquarium cabinet. In some circumstances ozone production can be almost doubled. The unit utilises silicagel as drying component. The silicagel should be changed as soon as the indicator beads change their colour from orange to blue.

Item code	Item
65027	Ozone Booster

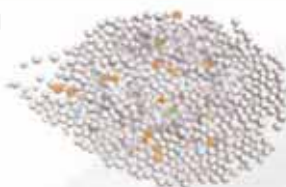

Silicagel

Silicagel

Ozone Booster - Refill

Dry granulate with high de-hydration capacity. The indication pearls changing colour from orange to blue if wet.

Item code	Item
12730	Silicagel 600 g/app. 1,000 ml

M-ventil Eco

Electronic shut-off valve for CO₂, Eco

The M-ventil Eco is a quality valve with pressure fittings for 6 mm flexible hose with a maximum operating pressure of 1 bar. The power consumption is only 5 watts of electrical energy to prevent overheating. The valve can be connected to the corresponding CO₂ units. In conjunction with a pH controller, automatic control of the CO₂ supply and pH can be achieved. If used with a timer, the valve will provide a night shut off system. Only suitable for gases.



M-ventil Eco



Item code	Item
230.32	M-ventil Eco

Electrodes

Aqua Medic pH- and mV-electrodes (Redox-potential) are quality products designed for both accurate measurement and long, trouble free use. Both types of electrodes are available in three versions: Standard electrodes – with plastic shaft, glass electrodes – laboratory standard for extended performance. Electrodes with plastic shaft and PG 13.5 thread – pressure resistant up to 3 bar, and can be used in plumbing fittings or in a closed version of Nitratereductors and Calciumreactors.

The warranty for probes/electrodes is 6 months.

Electrode	Length up to the top	Length incl. top
Plastic probe pH	125 mm	160 mm
Plastic probe pH PG 13.5 short	70 mm	110 mm
Refillable pH probe with plastic shaft	125 mm	160 mm
Plastic probe mV	125 mm	160 mm
Glass probe mV	120 mm	160 mm
Plastic probe mV PG 13.5 short	70 mm	110 mm

Item code	Item
220.10	Plastic probe pH
220.13	Plastic probe pH PG 13,5 short
220.14	Plastic probe (refillable)
220.16	Plastic probe mV
220.17	Glass probe mV
220.19	Plastic probe mV PG 13.5 short



Electrodes



Test fluids

Test fluids

Electrode calibration fluids

The accuracy of all electrodes is dependent on their calibration. To ensure accurate readings, all electrodes need to be calibrated at regular intervals. To ensure that the fluid values used to calibrate the electrodes remain constant, regular replacement of these fluids should occur.

Item code	Item
230.004	pH 4 test fluid 60 ml
230.007	pH 7 test fluid 60 ml
230.009	pH 9 test fluid 60 ml
230.300	KCL-solution for pH + mV sensors 60 ml
230.230	230 mV test fluid 60 ml
230.400	Cleaning solution 60 ml
230.250	250 µS test fluid 60 ml
230.050	50 mS test fluid 60 ml

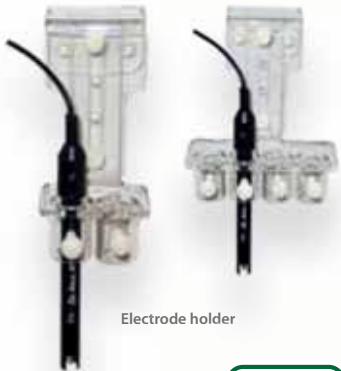

Electrode holder

Electrode holder 2 / 4

For use with up to 2 or 4 electrodes, easily attaches to the aquarium. The level of submergence of the electrodes is fully adjustable.

Item code	Item
230.62	Electrode holder 2
230.64	Electrode holder 4



platinum line plus - 24 V

Reverse osmosis unit

- reverse osmosis unit incl. high pressure pump for producing up to 400 litres of purified water per day
- for the production of soft water with low-salt content for fresh- and saltwater aquaria, for spraying terrariums and many other applications

The reverse osmosis system platinum line plus is a compact and versatile superior unit. It is supplied with three large 10" filter housings. The filter cartridges (activated carbon, fine filter and demineralization resin) can easily be replaced. The supplied pressure gauge will display the operation pressure at any time. All components, the prefilter housings and the membrane module are mounted onto a stable powder-coated bracket. The unit has a high pressure pump and a flushing valve and therefore, can achieve a high ratio of pure to waste water output up to 1:1. The salt removal rate is up to 99%. Due to the fully automatic back flushing and continuous monitoring of the pure water, the unit requires very little maintenance.

Dimensions (l x w x h): app. 38 x 22 x 47 cm

Tube's diameter: 1/4" - 4/6

Filling capacity for resin: app. 600 ml



platinum line plus - 24 V



Item code	Item
U800.65	platinum line plus - 24 V
Options:	
U711.100	Membrane 400/100 GPD for platinum line plus
U606.17	Sediment filter 5 µm 10" housing for premium line/platinum line plus
U606.10	Combined filter cartridge carb./sed. 10" housing for premium line/platinum line plus
U601.11	Demineralisation filter RO-resin 600 g/app. 1,000 ml can
U601.12	Demineralisation filter RO-resin 3,000 g/app. 5,000 ml bucket
U601.15	RO-resin cartridge, app. 600 ml
U601.21	indicator-resin



Sediment filter

RO-resin cartridge

Combined filter cartridge

RO-resin



RO-resin cartridge

Ion exchange resin cartridge for reverse osmosis system platinum line plus – with colour indicator

Used to remove the last remaining pollutants from RO water such as silicate, nitrate and other ions, by using ion exchange resin as the final stage on a reverse osmosis unit. It reduces the growth of diatom, if silicate levels in tap water are too high. The resin changes colour to indicate the efficacy of the filter material. When the conductivity of desalted osmosis water begins to rise again, the resin turns from blue to green and needs to be renewed.

Item code	Item
U601.15	RO-resin cartridge, app. 600 ml



indicator-resin

Ion exchange resin with colour indicator

Mixed bed demineralizer for removing silicate, nitrate and other ions from osmosis water. The special silicate resin helps to limit the growth of diatoms, especially for the aquarium hobby. Used to remove the last remaining pollutants from RO water, by using ion exchange resin as the final stage on a reverse osmosis unit. It reduces the growth of diatom, if silicate levels in tap water are too high. The resin is placed in designated cartridges (e.g. Aqua Medic demineralization filter, Aqua Medic platinum line plus, Top End Filter, RO-resin cartridge or other commercially available ultrapure water filters) after the reverse osmosis units. How much the osmosis water is freed from the ions that are still present depends on the residual salt content and the flow rate. Depending on the residual salt content and the flow rate, the osmosis water is released from remaining ions.

- disposable resin. The resin is equipped with a colour indicator that shows the efficiency of the filter material. If the conductivity of the desalted osmosis water begins to rise, the resin turns from blue to green and must be replaced.
- not rechargeable

Filling weight: 730 g / app. 1,000 ml

Item code	Item
U601.21	indicator-resin

easy line professional

For the purification of tap water, app. 190 – 800 l/day

For the production of soft and desalted water for salt- and freshwater aquaria, for spraying in terraria and many other applications.

The easy line professional reverse osmosis units are compact and powerful and fulfill the highest demands for water quality. A sediment filter retains all particles larger than 5 µm and a carbon filter protects the membrane by removing chlorine. The module consists of a membrane, pressure pipe and flow restrictor.

The membrane is the heart of the system and responsible for the pure water quality. We use the latest generation of TFC (Polyamide / Polysulfone) membranes to provide the highest quality treated water, providing a recovery ratio of approximately 3 – 4 : 1 concentrate:permeate, and a rejection rate of up to 98%. With the supplied chrome-plated tap extension, you can choose between filtered water (osmosis water) and tap water. This option allows the extension to be permanently connected to the tap.

Included in the delivery is a universal adapter for tool-free installation on a standard domestic water tap. Suitable for mixing nozzles with: 22 mm internal thread or 24 mm external thread (adapter included)

Dimensions (l x w x h): app. 370 x 160 x 160 mm



easy line professional



Accessories (incl.)

Item code	Item
U710.050	easy line 50 professional, app. 190 l/day
U710.100	easy line 100 professional, app. 300 l/day
U710.150	easy line 150 professional, app. 600 l/day
U710.200	easy line 200 professional, app. 800 l/day

easy line Filter Sets

Filter sets for replacing the filters of reverse osmosis systems of the series easy line and easy line professional

Consisting of:

- sediment filter
- activated carbon filter
- membrane

Item code	Item
U712.050	Filter Set EL/ELP + Membrane 50 for easy line 190 and easy line professional 50
U712.075	Filter Set EL + Membrane 75 for easy line 300
U712.100	Filter Set ELP + Membrane 100 for easy line professional 100
U712.150	Filter Set ELP + Membrane 150 for easy line professional 150
U712.200	Filter Set ELP + Membrane 200 for easy line professional 200



easy line Filter Sets



Activated carbon filter cartridge

Membrane

Sediment filter



easy line

easy line +
Top End Filter
(optional)



easy line

For producing purified tap water, app. 190/300 l/day

easy line 190 and easy line 300 reverse osmosis units are compact and powerful. A sediment filter retains all particles larger than 5 µm and a carbon filter protects the membrane by removing chlorine. In our units, only TFC (Polyamide / Polysulfone) membranes are used to provide the highest quality treated water, providing a recovery ratio of approximately up to 3 concentrate : 1 permeate, and a rejection rate of up to 98%.

Item code	Item
U700.25	easy line 190, 190 l/day
U700.30	easy line 300, 300 l/day

Options:

U601.20	Top End Filter
---------	----------------



easy line
Filter Sets

easy line Filter Sets

Filter sets for replacing the filters of reverse osmosis systems of the series easy line and easy line professional

Consisting of:

- sediment filter
- activated carbon filter

Item code	Item
U711.000	Filter Set EL/ELP for easy line and easy line professional



Activated
carbon
filter cartridge

Sediment filter

premium line

For producing of app. 190 – 600 litres (app. 50 – 158 gal) of purified tap water per day

The premium line reverse osmosis units are compact and versatile superior grade products. They are supplied with two large (10") prefilter housings and their activated carbon and 5µ sediment cartridges can easily be replaced. The membrane, the heart of the unit, is offered in 3 sizes: 190 l/day and 300 l/day as well as a double membrane of 600 l/day. The membrane housing includes a combined flushing valve and flow restrictor and the system can achieve a concentrate to permeate recovery ratio of up to 3 to 1 with a rejection rate of app. 95%. The pre-filter housings and the membrane module are mounted onto a strong powder coated wall mounting bracket.



Item code	Item
U800.25	premium line 190, 190 l/day
U800.30	premium line 300, 300 l/day
U800.35	premium line 600, 600 l/day

Options:

U606.17	Sediment filter 5 µm 10" housing for premium line/platinum line plus
U606.10	Combined filter cartridge carb./sed. 10" housing for premium line/platinum line plus
U606.15	Activated carbon filter cartridge 10" housing for premium line
U711.050	Membrane 190 /50 GPD for premium line 190
U711.075	Membrane 300/75 GPD for premium line 300 and premium line 600 (2 pcs.)



Top End Filter

Ultrapure water filter with colour indicator

High levels of silica (silicates) in tap water are often a problem in the aquarium hobby despite the use of the most modern reverse osmosis systems. Even with retention rates of up to 99%, a residual silica concentration often remains in the pure water that can lead to problems with diatoms especially in saltwater aquaria. The Top End Filter is placed directly behind the reverse osmosis unit so that any remaining silica is removed from the ultrapure water. The colour indicator in the ion exchange resin shows when the filter material is worn. The binding capacity is exhausted with approx. 1,800 l water flow (depending on the water quality).

Included in shipment:

- filter housing filled with ion exchange resin (incl. colour indicator)
- wall bracket
- bracket for attaching to an existing reverse osmosis filter (e.g. easy line)
- high-quality 6 mm connection fittings
- grid plate with microfilter
- microfilter sponge
- 50 cm hose

Dimensions: Ø app. 71 mm, height app. 330 mm

Filling capacity: app. 500 ml

Item code	Item
U601.20	Top End Filter





antibac filter

antibac filter

Highly effective filter for osmosis units to remove germs and bacteria

The Aqua Medic antibac filter serves as a germ barrier for osmosis units. Its capillary membrane removes unwanted bacteria, parasites, spores and fungi from the reverse osmosis water. The antibac filter is simply placed in the osmosis outlet and can produce around 8,500 liters of sterilized osmosis water before it has to be replaced. With osmosis units, there is a risk of contamination especially if used irregularly. In addition, the waste water hose of an osmosis system is often connected directly to the drain. As a result, there is a risk that bacteria and other germs from the waste water will migrate into the system, this is referred to as "recontamination". The Aqua Medic antibac filter ensures hygienically perfect osmosis water.

Included in delivery:

- antibac filter
- 2 x mounting bracket
- 2 x fittings for hose 4/6 mm

Item code	Item
U601.19	antibac filter



Merlin plus (PRF-RO)

Merlin plus (PRF-RO)

Reverse osmosis unit with a capacity of app. 2,000 l/day (app. 500 gpd)

The Merlin plus (PRF-RO) reverse osmosis unit operates using just the mains pressure of the tap water (3 – 4 bar), without the need for a high pressure pump. It has 2 high flow membranes and a combined activated carbon/sediment prefilter. Salt rejection is app. 90 – 95% and the recovery ratio (purewater : wastewater) is 3 – 4 : 1.

We recommend an M-ventil to give automatic control of the unit.

Item code	Item
U600.71	Merlin plus (PRF-RO)

Options:

U600.70-2	Carbon postfilter Merlin II/plus (PRF-RO)
U600.70-3	Combined filter cartridge Merlin II/plus (PRF-RO)
U605.75	Membrane Merlin II/plus (PRF-RO)

Demineralisation filter

Used to remove the last remaining pollutants using a special ion exchange resin and is installed after the reverse osmosis unit. It reduces the growth of diatom, if silicate level of tap water is too high.

Included:

- filter housing 10"
- filter insert incl. demineralisation resin
- mounting bracket with fastening screws
- fittings for 4/6 mm hose

Item code	Item
U601.10	Demineralisation filter 10"
U601.11	Demineralisation filter RO-resin 600 g/app. 1,000 ml can
U601.12	Demineralisation filter RO-resin 3,000 g/app. 5,000 ml bucket



RO-resin

Ion exchange resin

Used to remove the last remaining pollutants using a special ion exchange resin, and is placed after the reverse osmosis unit. It reduces the growth of diatom, if silicate level of tap water is too high.

Item code	Item
U601.11	Demineralisation filter RO-resin 600 g/app. 1,000 ml can
U601.12	Demineralisation filter RO-resin 3,000 g/app. 5,000 ml bucket





Membrane, Filter, Filter inserts

Item code	Item
U711.050	Membrane 190 /50 GPD for easy line 190 and premium line 190
U711.075	Membrane 300/75 GPD for easy line 300, premium line 300, premium line 600 (2 pcs.)
U711.100	Membrane 400/100 GPD for platinum line plus
U711.150	Membrane 600/150 GPD for easy line professional 150
U711.200	Membrane 200 GPD for easy line professional 200
U605.01	Activated carbon prefilter w. fittings for easy line
U605.06	Sediment 5 µm prefilter w. fittings for easy line
U606.17	Sediment filter 5 µm 10" housing for premium line/platinum line plus
U606.10	Combined filter cartridge carb./sed. 10" housing for premium line/platinum line plus
U606.15	Activated carbon filter cartridge 10" housing for premium line
U606.65	Filter cartridge for housing 10" empty
U600.70-2	Carbon postfilter Merlin II/plus (PRF-RO)
U600.70-3	Combined filter cartridge Merlin II/plus (PRF-RO)
U605.75	Membrane Merlin II/plus (PRF-RO)
U601.15	RO-resin cartridge, app. 600 ml



PE-tube

Item code	Item
U630.00	PE-tube 4/6 mm / 1 m (price per metre), minimum quantity 10 m



tap connector

Switchable water tap connection for the operation of osmosis

The water tap connection can be connected (without adapter) to water taps with ½" external thread or (with adapter) M24 internal thread. A side connection allows the connection of an osmosis unit with a standard pressure hose. A tap can be used to switch between tap water withdrawal and operation of the osmosis unit. The tap connector has a ½" internal thread plus a thread adapter from ½" external thread to M24 external thread.

Item code	Item
U710.010	tap connector

reactor compact

CO₂-reactor with integrated non-return valve and bubble counter for aquaria up to 200 liters.

Item code	Item
71630	reactor compact



reactor compact

**regular mini**

Pressure regulator with bottle pressure display and needle valve to use with CO₂-bottles. Connecting thread W21,8 x 1/14"

Item code	Item
71610	regular mini



regular mini

**silicone hose 4/6**

4/6 mm hose, 5 meter

Item code	Item
71614	silicone hose 4/6



silicone hose

**pipe holder**

Holder for 6 mm CO₂-hose to fit onto glass of up to 10 mm thickness.

Item code	Item
71615	pipe holder



pipe holder

**bubble counter plus**

Bubble counter for use with CO₂-systems for the supply of water plants.

Item code	Item
71650	bubble counter plus



bubble counter plus

**CO₂ indicator**

Indicator for showing the carbon dioxide content in freshwater aquaria. Incl. 10 ml CO₂ indicator solution.

Item code	Item
71640	CO ₂ indicator

CO₂ indicator



CO₂ indicator solution

CO₂ indicator solution

Inject 1 ml of CO₂ indicator solution into CO₂ indicator directly. It is recommended to change the CO₂ indicator solution once a month. Compare the color of the CO₂ solution with the included scala and determine the CO₂ content of your aquarium water.

Item code	Item
71641	CO ₂ indicator solution 10 ml



reactor 100

reactor 100

Passive CO₂-reactor for aquaria up to 250 litres (app. 62.5 gallons)

reactor 100 is operated without an additional pump. The CO₂ is forced through a ceramic diaphragm. This creates tiny bubbles that rise slowly in the water and dissolve on their way up.

Item code	Item
71130	reactor 100



reactor 1000

reactor 1000

Closed CO₂-reactor for external use for aquaria up to 2,000 litres (app. 500 gallons)

reactor 1000 is a hermetically sealed unit for introducing CO₂ into larger aquaria. The universal mounting plate enables it to be mounted outside the aquarium or inside the cabinet. This powerful unit can supply aquaria up to 2,000 litres (app. 500 gallons) with CO₂. With 12/16 mm hose.

Required pump power: 1,500 – 2,000 l/h. (app. 375 – 500 gal.)

Total height: app. 37 cm (app. 15"); Ø app. 8 cm (app. 3")

Item code	Item
71113	reactor 1000



regular

regular

Pressure regulator for precise control of CO₂ dosing into the aquarium

regular is chrome plated and offers: a fixed working pressure of app. 1.5 bar, a needle valve for fine adjustment, two pressure gauges to show both the cylinder and working pressures. regular fits industry standard CO₂ cylinders having an external valve. Connecting thread W21,8 x 1/14".

Item code	Item
71011	regular with 2 pressure gauges



counter

counter

CO₂-bubble counter incl. check valve

High-quality material allows longer operation life and a reliable operation. Bubble counter with combined check valve. The backflow is effectively prevented by the check valve. Suitable for hose connection 4/6 mm. 4/6 mm verwendbar.

Item code	Item
71850	counter

megatools

scissors 60

Straight stainless steel scissors for pruning plants in the aquarium.
Length app. 60 cm

Item code	Item
39010	scissors 60

**scissors 60 curved**

Curved stainless steel scissors, for easy trimming of ground covering plants.
Length app. 60 cm

Item code	Item
39011	scissors 60 curved

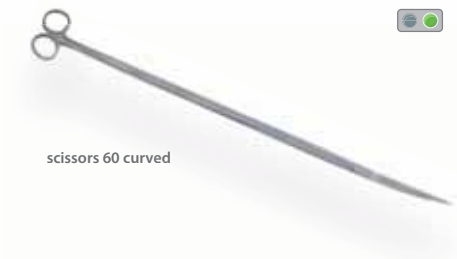
**t-rail 60**

Straight stainless steel pliers with clip, for effortless planting of aquarium plants.
Length app. 60 cm

Item code	Item
39020	t-rail 60

**tweezers 60**

Straight stainless steel tweezers to assist in the planting of aquarium plants in inaccessible areas of the aquarium. Length app. 60 cm

Item code	Item
39030	tweezers 60





coral cutter mini

coral cutter mini

Coral pliers are made of stainless steel incl. scissors of 2 cm in length for fragmenting small stone corals. Rinse thoroughly in fresh water, after being in contact with saltwater. Grease the joint regularly with vegetable oil. Length: app. 10 cm

Item code	Item
39050	coral cutter mini



coral cutter midi

coral cutter midi

Coral pliers are made of stainless steel incl. scissors of 3.5 cm in length for fragmenting strong stone corals. Rinse thoroughly in fresh water, after being in contact with saltwater. Grease the joint regularly with vegetable oil. Length: app. 18 cm

Item code	Item
39051	coral cutter midi



coral cutter moon type

coral cutter moon type

Coral pliers are made of stainless steel for fragmenting stone corals with particularly thick and hard coral branches. Rinse thoroughly in fresh water, after being in contact with saltwater. Grease the joint regularly with vegetable oil. Length: app. 20 cm

Item code	Item
39052	coral cutter moon type



aqua gloves

aqua gloves

The 75 cm long Aqua Medic aqua gloves not only offer protection against wet sleeves, they also reduce the risk of a possible infection of the aquarist with fish tuberculosis or inflammation of the hands due to minor skin injuries caused by fine needles on the reef rock or bristle worms. (Contains natural latex.)

Item code	Item
66301	aqua gloves - one size

food pipe

Food station for aquaria

- for feeding fish and corals
- prevents early loss of food via the drain
- with magnetic holder for easy attachment to an aquarium pane

Item code	Item
501.91	food pipe



injection set

Syringe set

Plastic syringes ranging from 1 ml to 50 ml for various aquarium applications such as measuring and dosing liquids, spraying glass roses and manjanos, replacing the electrolyte in refillable pH and mV electrodes, density measurement with refractometers, and much more.

Including fine cannulas made of saltwater-resistant plastic.

Contents:

- 6 x syringes, 1 ml, 2.5 ml, 5 ml, 10 ml, 20 ml, 50 ml
- 6 x fine cannulas
- silicone tube, 50 cm, Ø 4/6 mm

Item code	Item
39060	injection set



catch bowl

Fishing scoop for gentle and easy removal of fish and invertebrates from the aquarium

Dimensions: Length approx. 40 cm, Ø approx. 12 cm

Item code	Item
501.82	catch bowl



silicone hose 4/6

4/6 mm hose, 5 meter

Item code	Item
71614	silicone hose 4/6





Fish trap



Fish trap

Trap for catching a particular fish in an aquarium

Aquaria can have many hiding places making catching an individual fish extremely difficult without being time consuming and stressful to both yourself and the aquarium inhabitants and can also cause damage to invertebrates when trying to use a net.

Fish trap is baited with some food and as soon as the desired fish has entered the trap the closing mechanism is simply released – by hand. The Fish trap is constructed in such a way that when it is removed from the aquarium with the fish inside it remains half full of water. This method considerably reduces the stress on the fish. Incl. rubber sucker twin

The double sucker is made of a highly quality flexible material and is particularly suitable for fixing our Fish trap to the inside glass of an aquarium.

We recommend using three double suckers to ensure safe fixing of the fish trap. By using this type of fixing, the fish trap does not have to be in contact with the base of the aquarium, making it easier to catch fish than was possible before.

Dimensions (l x w x h): app. 27.5 x 17 x 17 cm

Item code	Item
501.80	Fish trap



rubber sucker twin

rubber sucker twin

The double sucker is made of a highly quality flexible material and is particularly suitable for fixing our Fish trap to the inside glass of an aquarium.

We recommend using three double suckers to ensure safe fixing of the Fish trap. By using this type of fixing, the Fish trap does not have to be in contact with the base of the aquarium, making it easier to catch fish than was possible before.

You can also use the double sucker to connect other items with smooth surfaces to each other. (Ø app. 38 mm, h app. 25 mm)

Item code	Item
418.11	rubber sucker twin 3 pcs.



Trap-pest

Trap-pest

Universal trap for crabs, snails and bristle worms – for fresh- and saltwater

Trap-pest is an automatic trap for removing undesirable bristle worms, crabs or snails from an aquarium. Bristle worms crawl through a funnel into the trap and cannot find their way out whilst crabs and snails pass through a one way curtain which blocks their return path. The Trap-pest is simply baited from the outside.

Dimensions (l x w x h): app. 27.5 x 17 x 17 cm

Item code	Item
501.81	Trap-pest

filter bag multi

Filter bag

Filter bag (\varnothing app. 10.5 cm) with 1,000 μm for use as a prefilter in a cabinet filter, without holder

Item code	Item
429.12	filter bag multi (2 pcs.) \varnothing app. 90 mm, length app. 230 mm

filter bag multi

**filter bag**

Zip up media bag

Filter bags are designed to contain fine filter media, such as activated carbon, antiphos Fe or other granular media. The filter bag is fitted with a zip fastener for quick and easy replacement of the media.

Item code	Item
429.01	filter bag 1, 2 pcs., 22 x 15 cm (app. 8.6" x 5.9")
429.02	filter bag 2, 2 pcs., 22 x 30 cm (app. 8.6" x 11.8")
429.03	filter bag 3, 2 pcs., 22 x 45 cm (app. 8.6" x 17.7")

filter bag

**prefilter bag**

Filter bag (\varnothing app. 10.5 cm) with 200 μm for use as a prefilter in a cabinet filter. Incl. acrylic holder for max. 14 mm glass.

Item code	Item
429.10	prefilter bag
429.11	filter bag 4 (2 pcs.) - replacement \varnothing app. 90 mm, length app. 350 mm

prefilter bag



filter bag 4





TopView 200



TopView 200

Aquarium Viewing and Photography Glass

- made of high quality acrylic glass
- floats on the water surface
- allows a great view through the water surface of the aquarium to the coral world
- ideal for photographing the corals, from a different perspective
- no distorted images
- current pumps do not have to be switched off
- a smartphone can be conveniently inserted directly into the glass to avoid annoying light reflections

Dimensions: Ø app. 200 mm, height: app. 50 mm

Item code	Item
65960	TopView 200



Coral Glasses



Coral Glasses

For improved colour rendering, of the blue light spectrum

The Coral Glasses absorb the blue colour spectrum of the aquarium lighting and allow the corals to be viewed in their natural, bright colours.

- incl. storage box

Not suitable for permanent wearing.

■ See the true colours of your corals!



■ available in July 2023!

Item code	Item
65990	Coral Glasses NEW

Mega Mag

Magnetic glass cleaners for panes between 6 and 18 mm (app. 0.24 and 0.72")

Mega Mag magnetic glass cleaners are waterproof, corrosion-resistant and suitable for use in fresh and saltwater aquaria, removes debris and algae from the aquarium glass. The floating half of the magnet that is placed within the aquarium can be easily attached to help avoid scratching due to sand and gravel being trapped between the two halves.



Mega Mag	Mega Mag S	Mega Mag M	Mega Mag L
Glass thickness up to	6 mm	12 mm	18 mm
Cleaning surface	app. 62 x 33 mm	app. 98 x 36 mm	app. 85 x 67 mm

Item code	Item
67021	Mega Mag S
67022	Mega Mag M
67023	Mega Mag L

Mega Mag 1 + 2

Magnetic glass cleaners for panes between 10 and 32 mm (app. 0.4" and 1.25")

Mega Mag glass cleaners are completely sealed and corrosion protected and are suitable for use in fresh- and saltwater aquaria. The cleaning pads of the inner magnet and the felt pads of the outer magnet can be easily replaced. Mega Mag glass cleaners contain extremely strong magnets and have to be handled with care. Cleaning surface 8 x 11 cm.

Mega Mag 1 for glass from 10 – 19 mm (app. 0.4" – 0.75")

Mega Mag 2 for glass from 15 – 32 mm (app. 0.6" – 1.25")

Item code	Item
67000	Mega Mag 1
67001	Mega Mag 2
67101	Spare pads Mega Mag 1 & 2, 2 pcs.



Mega Mag 3

Magnetic glass cleaner for large aquaria

Mega Mag 3 is a powerful magnetic cleaner for large aquaria with panel thicknesses up to 55 mm. As with the smaller models in the Mega Mag range, the cleaning pads are easily renewed or a plexipad can be fitted for the cleaning of acrylic aquaria. Cleaning surface 10 x 14 cm.

Item code	Item
67002	Mega Mag 3
67103	Spare pads Mega Mag 3, 2 pcs.





plexipad

plexipad Mega Mag

Cleaning pad for Mega Mag to protect acrylic

When using Mega Mag cleaners on acrylic aquaria the existing glass cleaning pad should be replaced with plexipad. This material is specially selected for cleaning acrylic and is fixed on the inner magnet to protect the acrylic panels from scratching. plexipad can be easily changed when worn.

Item code	Item
67100	plexipad Mega Mag 1 + 2
67102	plexipad Mega Mag 3



Mega Mag magnetscraper

Mega Mag magnetscraper

Blade accessory for Mega Mag

magnetscraper is an accessory for the Mega Mag glass cleaner. It converts the Mega Mag from a simple magnet into a bladed cleaner. Now, even the most resistant algae can be removed. The magnetscraper simply snaps onto the Mega Mag 1 or Mega Mag 2 and is secured with a single screw. It can easily be removed if required. Dimensions: 80 x 22 x 0,20 mm

Item code	Item
67010	Mega Mag magnetscraper



magnetscraper blades

magnetscraper blades

Spare blades for Mega Mag

Dimensions: 80 x 22 x 0,20 mm

Item code	Item
67011	magnetscraper blades, package 5 pcs.



scraper

scraper

Aquarium glass cleaner

scraper is a multiple use blade cleaner. The 150 mm wide blade makes it easy to remove even the most resistant calcareous algae from the aquarium glass. Extended durability with stainless steel anti-corrosive coating – specially made sharp blade. The removable blade protector also acts as a squeegee for cleaning the outside of the aquarium glass. A unique feature of the scraper is the hinge which allows the blade head to be turned through 180°. This facility allows the user to clean the aquarium even when the tank decoration, such as rocks or roots, are very close to the glass. Dimensions: 150 x 22 x 0,20 mm

Item code	Item
66000	scraper
66001	scraper blades 5 pcs.

aqua smoothy

Superfine micro porous fibre cloths, for smear free cleaning of the outside glass of the aquarium, lint-free. The aqua smoothy is very absorbent and can be used either wet or dry. It will safely and gently remove salt encrustation or fatty residues without the use of aggressive cleaning agents. Can also be used on most other smooth surfaces.

Contents: 2 x cloths, each approximately 40 x 40 cm

Microfiber: 80% polyester, 20% polyamide.

Item code	Item
66100	aqua smoothy



aqua smoothy

Reef Construct

Two-component resin

For safe and easy attachment of stones and corals in the aquarium.

A two-part epoxy putty to secure rock and hard and soft corals in the aquarium. Reef Construct solves many of the problems encountered during the aqua-scaping of fresh- and saltwater aquaria. Reef Construct is a fast curing, two-part epoxy putty that can even be used underwater. It adheres to rock, wood, metal, glass, plastic, concrete and most other materials.

Item code	Item
420.60	Reef Construct, 2 x 56 g (2 x app. 2 oz) sticks
420.61	Reef Construct, 1,008 g, 18 x 56 g (18 x app. 2 oz) sticks



Reef Construct

Coral Construct

Coral glue

For safe and easy attachment of coral frags inside and outside the aquarium. Harden quickly in and outside of the water, Cyanoacrylate

Item code	Item
420.72	Coral Construct - 2 x 5 g
420.70	Coral Construct - 20 g



Coral Construct

hot construct

Coral glue

hot construct is an easy-to-use glue for synthetic material for quick and easy gluing of coral fragments (layers). It is free from solvents. Unused material can be reactivated in hot water and reused. Suitable for use above and under water.

Item code	Item
420.80	hot construct SALE



hot construct



defroster

defroster

For defrosting of frozen food and enrichment with amino acids and vitamins

For salt- and freshwater fish. The frozen food is thawed in the defroster box, protected from light and vitamin saving. With the defroster sieve, it is separated from the nitrate and phosphate enriched thawing water and can be enriched with essential vitamins and amino acids (aminovit).
Incl. defroster box with lid and sieve.

Item code	Item
68000	defroster



frag board

frag board

Retaining plate (app. 15 x 15 cm) for holding several coral pins

By using the supplied suction cups, the retaining plate can be placed anywhere on the inner side of the aquarium. Thereby, the frags can be put in an optimal position for illumination. Thus, optimal growth of the frags can be significantly stimulated. Incl. 10 x coral pins.

Item code	Item
230.04	frag board



coral pins

coral pins

Frag stones

Item code	Item
230.06	coral pins (10 pcs.)
230.16	coral pins (100 pcs.)



pump brush

pump brush

Cleaning brush

Universal cleaning brush for aquarium equipment. With stiff bristles, areas that are difficult to access e. g. pumps and other aquarium equipment, can be cleaned more easily.
Length: approx. 14 cm

Item code	Item
100.905	pump brush

hopstop

Hop protection for open top aquaria

Helps prevent nocturnal fish from jumping out.

Content: 6 holders (combfix) and 3 plastic plates each app. 480 x 50 mm



hopstop

Item code	Item
418.12	hopstop

hose clip

Plastic clip

Flexible plastic clip designed for the safe fastening of hoses.



hose clip

Item code	Item
410.38	hose clip Ø 5 – 6 mm
410.39	hose clip Ø 6 – 7 mm

Coral strap

Secure strap for soft corals and live rock

Extra wide strap with rounded and thickened edges that do not cut into the tissue of the corals. For vegetative propagation of the soft corals. Saltwater resistant and PVC-free. Re-usable! Length app. 31 cm



Coral strap

Item code	Item
39520	Coral strap (5 pcs.)

Coral holder

The Aqua Medic Coral holder is the solution to present invertebrates and clams in shop systems. The holder has a flexible system, adjustable on the dimensions of the animals. With a water-resistant marker, the holder can be signed with name of the species and price.



Coral holder

Item code	Item
230.03	Coral holder



Trickle plate

Trickle plate

Trickle plate, 15 x 15 cm (app. 6" x 6"). Can be mounted on the rectangular pipe to evenly distribute the water.

Item code	Item
415.00	Trickle plate 15 x 15 cm SALE



Lid for trickle plate

Lid for trickle plate

Top lid for trickle plate, 15 x 15 cm (app. 6" x 6"). With a connection for 20 mm Ø pipe.

Item code	Item
415.20	Lid for trickle plate 15 x 15 cm SALE



Bottom plate

Bottom plate

Base for rectangular pipe, 15 x 15 cm (app. 6" x 6"). Can be glued to the bottom of the rectangular pipe.

Item code	Item
415.25	Bottom plate 15 x 15 cm SALE



Grid for quadratic pipe

Grid for quadratic pipe

Grate 15 x 15 cm (app. 6" x 6"). Grate for rectangular pipe, useful for holding filter material in place.

Item code	Item
415.30	Grid for quadratic pipe 15 x 15 cm SALE



aqua grid

aqua grid

Grid plate

The aqua grid is a versatile plastic grid that can be used in many applications in the aquarium itself or within a sump/filter system. A unique highly stable plug-in system in the form of slot and key on all sides allowing multiple grids to interconnect to form a smooth surface of varying sizes depending on your needs. The aqua grid is an excellent base for live rock and can also be used on the base of the aquarium, in filtration systems or for displaying corals in the retail environment.

Dimensions: app. 305 x 305 x 10 mm, grid size: 13 x 13 mm

Item code	Item
415.80	aqua grid

Overflow comb

comb 50 incl. holder + clip

Overflow comb, for the construction of aquarium overflows

The water runs evenly through the comb. Plant debris and dirt are trapped, fish remain in the aquarium. The retainer for overflow comb is glued on to the overflow. The comb is inserted in the retainer and can easily be removed for cleaning. It can also be used with a flexible holder (combfix).

Alternatively, the overflow comb can simply be attached directly to the glass pane with the attached clips without using the retainer.

Suitable for glass thickness 6 – 8 mm

Length: app. 50 cm , height incl. retainer: app. 8 cm, height excl. retainer: app. 5.5 cm, length of teeth: app. 3.7 cm

Item code	Item
418.05	comb 50 incl. holder + clip

comb 50 incl. clip

Overflow comb, for the construction of aquarium overflows

The water runs evenly through the comb. Plant debris and dirt are trapped, fish remain in the aquarium. Overflow comb without retainer, incl. clips. The overflow comb is simply attached to the glass pane using the attached clips. The overflow comb can easily be removed for cleaning.

Suitable for glass thickness 6 – 8 mm

Length: app. 50 cm, height: app. 5.5 cm, length of teeth: app. 3.7 cm

Item code	Item
418.08	comb 50 incl. clip

comb 40 incl. clip

Overflow comb, for the construction of aquarium overflows

The water runs evenly through the comb. Plant debris and dirt are trapped, fish remain in the aquarium. Overflow comb without retainer, incl. clips. The overflow comb is simply attached to the glass pane using the attached clips. The overflow comb can easily be removed for cleaning.

Suitable for glass thickness 10 – 12 mm

Length: app. 40 cm, height: app. 5.5 cm, length of teeth: app. 3.7 cm

Item code	Item
418.07	comb 40 incl. clip

comb 32 incl. holder

Overflow comb, for the construction of aquarium overflows

The water flows evenly and fish, plant matter and coarse detritus are prevented from entering the overflow chamber. The holder is glued on the overflow chamber and the overflow comb is pressed securely into the holder whilst leaving it easy to remove for cleaning and maintenance.

Length: app. 32 cm, (app. 12.8"), height: app. 6 cm (app. 2.4"), length of teeth: app. 2.2 cm (app. 0.88")

Item code	Item
418.00	comb 32 incl. holder





combfix

combfix

Holder for overflow comb

Optional support for fixing the overflow comb to the aquaria without the need for gluing.

Item code	Item
418.06	combfix 6 pcs.



Round grate

Round grate

Ideal for preventing larger detritus flowing through. They are manufactured in three sizes. Ø 40 mm, 50 mm and 63 mm (app. 1.6", 2" and 2.5")

Item code	Item
415.31	Round grate 40 mm black
415.41	Round grate 40 mm transparent
415.32	Round grate 50 mm black
415.42	Round grate 50 mm transparent
415.33	Round grate 63 mm black
415.43	Round grate 63 mm transparent



Tank union

Tank union

Tank union from ABS for the connection of aquaria to PVC hard pipes.

	D1	D2	G	L1	L2	L3	glass drilling
D 25	55	25	1"	46	22	19.5	35
D 32	65	32	1 1/4"	46	22	18	45
D 40	80	40	1 3/4"	55	26	20	55

Item code	Item
417.25	Tank union D 25
417.32	Tank union D 32
417.40	Tank union D 40



Adapter union AM

Adapter union

Adapter union AM from ABS for pipe 25/32, 32/40 mm and 40/50 mm.

Item code	Item
416.125	Adapter union AM 25 mm
416.132	Adapter union AM 32 mm
416.140	Adapter union AM 40 mm

aqua divider

With aqua divider it is possible to mount a glass sheet into an aquarium or terrarium without using any glue. The groove is holding a 4 mm glass sheet. The fastening is done by the rubber suckers. With aqua divider you can separate animals inside of the aquarium.

Item code	Item
418.10	aqua divider 4 pcs.



aqua divider

Outlet strainers

Outlet strainers are manufactured out of ABS pipe and have slits to prevent coarse detritus passing through. Available in the following diameter pipe sizes: 20 mm, 25 mm, 32 mm, 40 mm, 50 mm, 63 mm.

Item code	Item
418.21	Outlet strainer 20 mm, length app. 82 mm
418.20	Outlet strainer 20 mm, length app. 160 mm
418.25	Outlet strainer 25 mm, length app. 160 mm
418.32	Outlet strainer 32 mm, length app. 200 mm
418.40	Outlet strainer 40 mm, length app. 200 mm
418.50	Outlet strainer 50 mm, length app. 240 mm
418.63	Outlet strainer 63 mm, length app. 240 mm



Outlet strainers

Reducing T-piece

Reducing T-pieces are used for the connection of bypass filters like the Nitrate-reductor and the Calciumreactor.

Item code	Item
410.41	Reducing T-piece 9/12 - 4/6
410.40	Reducing T-piece 12/16 - 4/6
410.42	Reducing T-piece 16/22 - 4/6



Reducing T-piece

valve

The regulation valve can be used for both air and water. High quality plastic ensures a long service life.
2 pcs. per package

Item code	Item
411.42	valve 12 – 14 mm / for 12/16 tube SALE
411.44	valve 20 – 22 mm / for 19/27 tube SALE



valve



Regulation valve FBS

Regulation valve FBS

High quality regulation valve for hose inlet diameter in 4/6 mm and 6/8 mm – outlet diameter 4/6 mm. Connection fittings can be changed. Durable materials ensure low wear for constant adjustment. The regulation valve can be used for air and for water (e. g. Nitratereducator and Calciumreactor).

Item code	Item
410.44	Regulation valve FBS



Regulation valve 4/6

Regulation valve 4/6

Regulation valve for tube diameter of 4/6 mm. The regulation valve can be used for both air and water (Nitratereducator and Calciumreactor). High quality plastic ensures a long service life. The flow can be easily adjusted by the fine thread. In an attractive blister pack.

Item code	Item
410.47	Regulation valve 4/6 mm 2 pcs.



Non-return valve 4/6

Non-return valve 4/6

Check valve for a tube of 6 mm. Suitable for gas and water. In an attractive blister pack

Item code	Item
410.43	Non-return valve 4/6 mm 2 pcs.



Rust Protect



Rust Protect

Anti-corrosion and maintenance spray for metallic components

In aquarium cabinets with an open filter tank, wear and corrosion on the hinges caused by splashes and condensation can hardly be avoided. If used properly, the protective film applied by Rust Protect prevents moisture from reaching the metal parts, which significantly reduces the risk of corrosion. Rust Protect does not resinify and is resistant to saltwater.

- saltwater-resistant
- no draining
- no resinification
- wear reduction
- corrosion protection
- long-term effect

Regular use is recommended.

Item code	Item
599.950	Rust Protect, 100 ml





AQUA MEDIC

E-Mail: info@aqua-medic.de

Managing Director: Dipl.-Ing. Oliver Wehage

HRB 16246 AG Osnabrück

VAT No.: DE 117575590

WEEE-Reg.-No.: DE 88550220

AB Aqua Medic GmbH

Gewerbepark 24 | 49143 Bissendorf, Germany | Phone +49 5402 99110 | Fax +49 5402 991119

Technical changes reserved

www.aqua-medic.de